

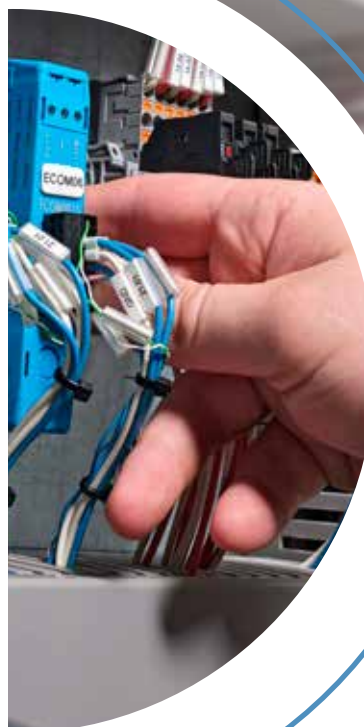

# Product Guide



**Solid State Relays**



**Magnetic Sensors**

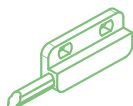

**Reed Relays & Switches**

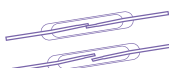

[celduc-relais.com](http://celduc-relais.com)

Made in France



# Our strengths

Made in France



**More than 50 years of high quality production in France.**



**In-depth analysis of customer requirements**

celduc® relais is the leading global expert and preferred choice for companies all over the world.



**Constant product development**

Our experienced R&D engineers at celduc® relais are constantly working on developing new products; these represent 10 to 15% of our total production output.



**Control of the complete process**

Design, development, production, testing and marketing.



**A global presence in over 60 countries,**

We have a local presence for our customers. We can therefore better understand their needs and provide them with the best solutions.



**We comply with the main international standards**

Our products are designed, tested and manufactured in accordance with the strictest international standards.





# celduc® relais products



## Solid state relays 2 > 47



Commonly known as SSRs, Solid State Relays represent 70% of celduc® relais' turnover. These innovative and very efficient devices are used to control all types of loads used across many industries, such as industrial heating, temperature control, motor control, automation interfaces, etc. The advantages of Solid State Relays (SSR) compared to ElectroMechanical Relays (EMR) are well known (see page 7). celduc® relais is the only solid state relay manufacturer in France, where our products have been produced for more than 50 years!



## Magnetic proximity sensors 48 > 62



Used for monitoring or controlling levels, motion, movement, position and rpm recording. The sky's the limit for these versatile sensors. Our sensors are used in both commercial and industrial applications.

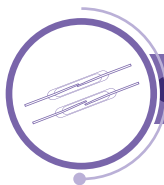

## Reed relays & switches 63 > 64



Our Reed switches are used in our own magnetic proximity sensors, Reed relays and Reed switches. Tried and tested, they can last for over 60 years. This product range meets the demands of an increasing number of new applications, thanks to their ease of use, compact size and reliability.



# Solid State Relays

## Contents

<b>SOME TECHNICAL REMINDERS</b> .....	3 to 9
<b>SELECTION MATRIX</b> .....	10 to 13
Function / No. of poles / Assembly type / Load type .....	10 to 11
Function / Voltage / Current .....	12 to 13
<b>INTERFACE RELAYS</b> .....	14 to 15
SLA / SLD / SPA / SPD .....	14
XK - DIN-Rail mounting .....	15
<b>RELAYS FOR PRINTED CIRCUIT BOARDS</b> .....	16 to 17
SKA / SKB / SKL .....	16
SKH - with integrated heatsink .....	17
SN8 - ultra-miniature and compact package .....	17
SHT - three-phase solid state relays .....	17
<b>SINGLE PHASE SOLID STATE RELAYS</b> .....	18 to 29
S07 - okpac® range - random .....	19
S08 - okpac® range - zero-cross - for most types of loads .....	19
S09 - okpac® range - zero-cross - for resistive loads AC-1 (AC-51) .....	20
SOL - flatpac® range - low profile .....	20
SOP - starting transformer .....	21
SON / SCFL - EMC optimized .....	21
SF - miniatures relays - with FASTON or PCB terminals .....	22
SCF - for resistive loads AC-1 (AC-51) - with FASTON terminals .....	22
SP7/SP8 - for most types of loads - with FASTON terminals .....	22
SOR - models with quick-connect terminals (push-in spring connectors) .....	23
SA / SAL / SAM - celpac® range - with screw connection on inputs .....	25
SU / SUL / SUM - celpac® range - with pluggable connector on inputs .....	26
ESUC - current monitoring module .....	27
ECOM - temperature controller, current monitor and communication interface .....	27
SOD / SILD / SOI - power SSRs with diagnostics .....	28-29
<b>TWO-PHASE SOLID STATE RELAYS</b> .....	30 to 32
SIB - 22.5mm compact version .....	30
SOB5 - with FASTON terminals .....	30
SOB6 - double input with connector CE100F ITW PANCON type or similar .....	30
SOB7 - random .....	31
SOB8 / SOB9 - zero-cross .....	31
SOBR - with "push-in" style spring connectors .....	32
<b>THREE-PHASE SOLID STATE RELAYS</b> .....	33 to 36
SMB - sightpac® 45mm - 2 leg three-phase SSRs .....	34
SMT - sightpac® 45mm .....	34
SGB - cel3pac® range - 2 leg three-phase SSRs .....	34
SGT - cel3pac® range .....	35
SGTR - with "push-in" style spring connectors .....	36
<b>FOUR-LEG SOLID STATE RELAYS</b> .....	36
SMQR - with "push-in" style spring connectors .....	36
SCQ - with FASTON terminals .....	36
<b>MOTOR CONTROL SOLID STATE RELAYS</b> .....	37 to 38
SMR / SGR / SG9 / SV9 / SW9 - AC reversing switches .....	37
SGRD / XKRD - DC reversing switches .....	38
SMCV/SMCW - AC three-phase softstarters .....	38
<b>CONTROLLERS</b> .....	39 to 43
Which control mode to choose? .....	39
SG4 / SO4 - phase angle controllers .....	40
SIL4 / SIM4 - phase angle controllers .....	41
S03 - burst control mode .....	41
Multizones power controller .....	41
SG5 - full wave pulse controllers .....	42
SWG5 - single phase power controllers .....	42
SWG8 - three-phase power controllers .....	42
SGTA / SVTA - three-phase proportional controllers .....	43
<b>DC SOLID STATE RELAYS</b> .....	44 to 45
MOSFET Technology .....	44
BIPOLAR Technology .....	45
IGBT Technology .....	45
<b>ACCESSORIES &amp; HEATSINKS</b> .....	46 to 47
Heatsinks .....	46
DIN-Rail adapters and other accessories .....	47



## Applications

Everyday new applications that need reliable, silent switching and long operating life use our innovative solid state relays.

Some examples are:

### Heating

- Plastic injection molding, extrusion and thermoforming
  - Food processing equipment (cooking ovens, coffee machines, ...)
  - Air conditioning, HVAC/R
  - Textile manufacturing
  - Residential heating
  - Infrared heating
  - Industrial processing machines (soldering equipment, ...)
- Etc



### Motor starting

- Pumps
  - Compressors
  - Conveyor systems
  - Fans
  - Hoists and cranes
- Etc



### Control

- PLC interface
  - Heating element control
  - Solenoid valves
  - Contactor Coils
  - Sensor management
- Etc



### Lighting

- Public lighting
  - Cinema, theatre lamps
  - Airport runway lamps
  - Road lighting
  - Railway signalling
- Etc



### Other

- Transformer starting
  - Power factor correction
  - Uninterrupted power supplies
  - Energy source switching
  - Capacitor bank control
- Etc





# Solid State Relays

## celduc® relais and custom products

celduc® relais can design specific products according to a customer's specifications or adapt existing products to a customer's needs..



- ▶ **Special development composed of SU SSRs and ESUC modules**  
This system includes all protections and has been designed to control 45 heating elements (9 groups of 5 heaters) with partial load break detection built in.



- ▶ **Solid state contactor for 3 phase motor**  
Dry contact control and spring terminals.



- ▶ **Motor reverser**  
This module integrates 5 SSRs.



- ▶ **Solid State Relays with IO-Link communication**  
It is a multi-zone control system with an IO-Link interface. Communications between systems is one of the great challenges of today and it is expected to be an even bigger challenge in the future!



- ▶ **Single phase Solid State Relay with onboard diagnostics**  
This is a zero-cross Solid State Relay with integrated diagnostics for load, network and relay output status. This information is given by a red LED and an open collector output. A microcontroller is used to manage the different functions of the relay.



- ▶ **« Ready to use product »** with integrated protection and built-in heatsink.



- ▶ **Hybrid Relay that does not require a Heatsink!** This Series combines the best of solid-state and electromechanical technology (elimination of the heatsink and EMC optimization in conducted emission).



- ▶ **DC motor reverser with power supply voltage monitoring and integrated protections**



## Our Technical Expertise

Here are our areas of expertise :

- ▶ Power and Control Electronics
- ▶ Power conversion
- ▶ Electromechanical Systems, electrical engineering
- ▶ Microcontrollers, Fieldbus Communication Network, diagnostic electronics
- ▶ Packaging (Molded plastic material, terminals and connections, mechanics, etc.)
- ▶ Thermal management
- ▶ EMC (ElectroMagnetic Compatibility)
- ▶ Integration and manufacturing processes
- ▶ Magnetic detection

Each request is different, each customer is unique



**A TEAM OF EXPERTS AT  
YOUR SERVICE**



# Solid State Relays

## Compliance with the standards specific to each industry

In many business sectors, equipment designers must use components that meet the standards that are specific to their industry.

With this in mind, celduc® offers devices that are suitable for use in multiple industries. For example :



All of our SO series okpac® relays , SU/ SA celpac® relays (including the current sensing module ESUC) and also the 2-phase SOB and 3-phase SGT series comply with **EN 61373** : shock and vibration standard for railway vehicles.

With respect to fire safety standards NF F16-101, NF F16-102, **EN 45545**, and EN 60695-2-10/11/12 (Glow Wire tests (GWFI – GWIT)) : the plastic covers and encapsulating resin of our SO series okpac® relays and SU/ SA celpac® relays comply with the standard and also meet the requirements of UL 94 V0.

Our products are also compliant with the **EN 50155** standard which applies to all electronic equipment used for the control, regulation, protection and power supply on rolling stock. **The following products are all EN 50155 compliant : SO887040, SO887940, SDI0501700, SDI0501710 and XKLD31006.**



In addition, some of our products fulfill the requirements of EN 60601-1 (VDE 0750) for medical applications.

## Standards

celduc® relais has developed all of its own test equipment. Our products are manufactured in accordance with the most stringent international standards.

- The solid state relays and contactors made by celduc® relais are manufactured in compliance with major international standards :
  - IEC/EN60947-4-3 for the other loads
  - IEC/EN60947-4-2 for motor control
  - IEC 62314
  - American and Canadian (UL, cUL, CSA)
  - IEC60335-1 – VDE0700-1
 Our products also comply with the main European CE marking directives.
- In the UL508A standard, the estimated short-circuit current rating is known as the SCCR: Short Circuit Current Rating. On April 1, 2015, our solid state relays SA / SU / SO with thyristors successfully attained 100kA UL SCCR certification. In fact, some customers request additional certification with an SCCR greater than 5kA in accordance with supplement SB, an appendix to UL 508A.
- Several of our products fulfil the requirements for KOSHA (S-MARK) and EAC (Russia-CIE) certification
- Our relay manufacturing process complies with ISO9001, version 2008. Our products contain extremely reliable components which allows them to operate with a very low level of electromagnetic interference. They therefore have the longest product lifetime on the market.



Product designed and manufactured under a quality management system certified AFAQ ISO 9001







## What is a Solid State Relay / Contactor?

Solid state relays are switching devices made using electronic components. We use the word "relays" as an analogy. An electromechanical relay is an electrical switch that is typically operated by using electromagnetism

to operate a mechanical switching mechanism. "Solid state" refers to the fact that these devices do not have any moving parts.

A solid state relay switches power (AC or DC) to the load circuitry and

provides electrical insulation between the control circuit and the load circuit. This technology competes with or is an addition to electromechanical relays and other switching technologies such as relays and mercury switches.

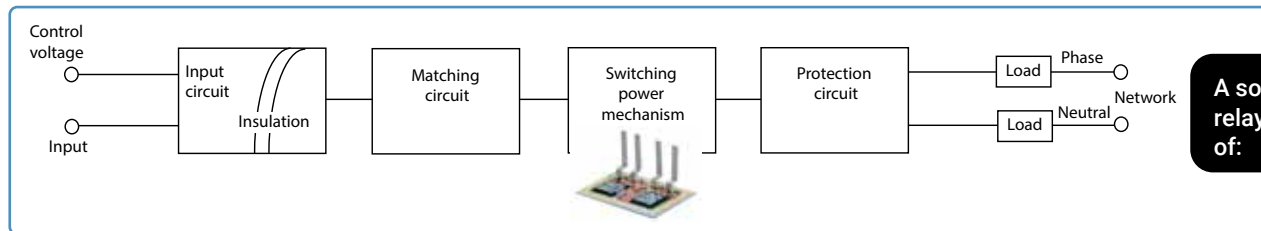

**A solid state relay consists of:**

## Advantages of Solid State switching

**Long service life**

Solid state relays do not have any moving mechanical parts so they are not subject to wear and tear or deformation. When used correctly, a solid state relay has a service life that is 200 times longer than that of an electromechanical relay (EMR).

**Very low energy consumption**

A low drive power makes it possible for the solid state contactors and relays to switch high power loads.

**Silent operation**

This technology does not generate acoustic noise while the outputs are changing state. This is a very important advantage when it comes to domestic and medical uses.

**Shock and vibration resistance**

No risk of accidental switching with solid state technology.

**Very high switching frequency**

A high switching frequency allows a very high degree of accuracy for regulation (temperature, etc.)

**Other types of control**

The SSR can be adapted to a custom switching cycle based on the application.

**Possible diagnostic functions**

## Zero-cross relay or Random relay?

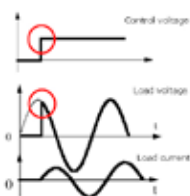

For **zero voltage control (or zero cross relay)**, power switching only takes place at the beginning of the alternation after the control has been applied. In fact, switching the power component only takes place at close to zero volts.

For resistive or capacitive loads, it is preferable to use zero cross relays which can limit the di/dt, disturbances on the network and increase the service life of the load and the relay.

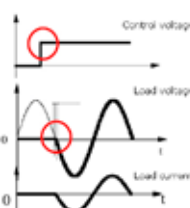

For **instantaneous control (or random relays)**, power switching takes place as soon as the control voltage has been applied (turn-on time less than 100µs). this type of control is used for all inductive loads where the phase shift between voltage and current can cause problems with zero-crossing relays. It is also used in applications where precise control of power to the load is required (phase-control applications).

**REMINDER**

Zero-cross for all loads / heavy duty loads: S08, SA8, SMT8, ...

Zero-cross for standard industrial loads / resistive loads: S09, SUL9, SGT9, ...

Random for inductive or motor loads: S07, SUL7, SGT7, ...



# Solid State Relays

## Thyristor Rating vs Switching Current

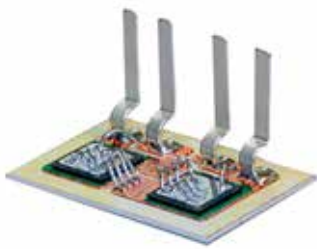

Thyristors are used as the switching components in solid state relays for alternating currents. The ratings of our power components are specified in this catalog. These products must be mounted on heatsinks in order to reach nominal performance. **“Thyristor rating”, which is an indication of the size of the power component, must not be confused with “switchable current” which depends on how the relay or contactor has been built and how it is used.** To correlate the switchable

current with the relay and your application, refer to the tables and thermal curves in our data sheets for products that are not equipped with heatsinks as standard.

Our solid state relays are fitted with back-to-back thyristors and use 4th generation TMS<sup>2</sup> technology. As a result our SSRs have a very long service life compared to the majority of products on the market (application note available on request).

## Voltage protection

Strong dv/dts may appear on the solid state relay terminals. These can also be generated by mains interference and by the zero cross current turn-off on inductive loads. In relays adapted to most loads, celduc@relais uses components with a high level of immunity and sometimes an RC protection network.

Overvoltages can also occur in the power supply and may cause the solid state relay to turn on, even without control. To solve

this problem, celduc@ uses 1200V or even 1600V components. In some ranges, it includes a surge arrester, also known as a varistor or a VDR (Voltage Dependent Resistor), placed on the solid state relay terminals on the socket side. For resistive load relays, celduc@ relais can also supply a surge protector (TVS (transient-voltage-suppression) diodes on triggers) which closes the relay in the event of an overvoltage to protect it.

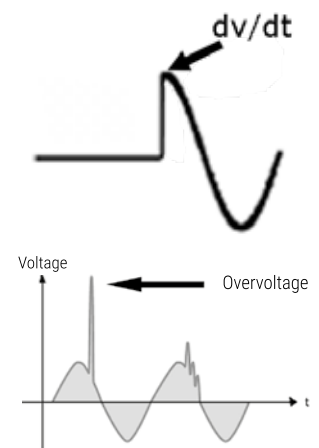

## Current protection

### Using a fuse

To protect the solid state relays against load short circuits, fuses must be used, particularly fast-acting fuses for small ratings. The I<sup>2</sup>t value of the fuse must be less than half of the I<sup>2</sup>t value of the relay.

### Using a circuit breaker

This method of protection can be adapted to solid state relays with a I<sup>2</sup>t value > 5000 A<sup>2</sup>s (technical note on request).

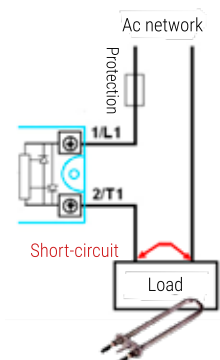

## Relay overheating / Heatsink

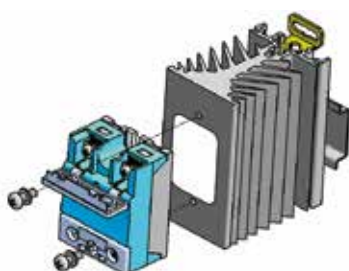

Solid state relays must cool down sufficiently so that the junction temperature (at the core of the power element) does not exceed the specified values: typically 125°C or 150°C (this value depends on the power components).

Cooling will prevent it from reaching heatsink temperatures (parts that can be touched) that are too high (90 or 100°C). To select the appropriate heatsink for your needs, use a calculation or refer to the graphs provided by celduc@ relais in the technical data sheets available on this website [www.e-catalogue.celduc-relais.com](http://www.e-catalogue.celduc-relais.com)



## Versatile, Easy and Quick connections

celduc® relays offers various types of connections on the power side and control side of its solid state relays (SSRs).

	Single phase SSRs		Two-phase SSRs		Three-phase SSRs		Four-Leg SSRs	
	Power wiring	Control wiring	Power wiring	Control wiring	Power wiring	Control wiring	Power wiring	Control wiring
Screws								
Removable screw connector								
Removable wire-to-board connector								
Removable spring connector								
Fast-On terminals								
PCB terminals								

### Power wiring

- Standard with screws



Special kit for high current for okpac range (ref. :1LK00700)

- Push-in spring terminals



- Screw connectors



- Fast-On terminals



- PCB terminals



- PCB terminals can also be used on the power side



### Control wiring

- Standard with screws



- Removable connectors



- Screw connectors



- Fast-On terminals

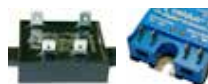

- PCB terminals



- PCB terminals can also be used on the control side





# Solid State Relays

Function	ON/OFF RELAY								
	No. Of poles	1 pole - Single Phase			1 pole EMC optimised	2 poles - Two-phase		3 poles - Three-phase	
Assembly type	Printed Circuit Board	DIN rail	Screw-in	Screw-in	DIN rail	Screw-in	Printed Circuit Board	DIN rail	Screw-in
<b>HEATING ELEMENTS: No inrush current</b>									
AC-1	SLA/SPA/STA SKA/SKB SKL/SKH	XKA SAL9/SAM9 SUL9/ SUM9 SOR-WF	S09/SOL9 SA9/SU9 SOR9	SCFL SON	XKM SOBR9-WF	SOB9 SOBR9	SHT	SMT SGT	SMT SGT SGTR
DC-1	SKD	XKD XKLD	SOM SCM SCI SMI SDI						
<b>INCANDESCENT LAMPS - INFRARED LIGHTS - INDICATOR LIGHTS: strong inrush currents</b>									
AC-5b	SKA SKL/SKH	XKA SAL8/SAM8 SUL8/ SUM8	S08 SA8/SU8	SCFL SON		SOB8		SMT SGT	SMT SGT
<b>DISCHARGE LAMPS: strong inrush currents, overvoltages at the turn off</b>									
AC-5a	SKA SKL/SKH	XKA SAL8/SAM8 SUL8/ SUM8	S08 SA8/SU8			SOB8			
<b>MOTORS: strong start currents</b>									
AC-3	SLA SPA/STA SKL/SKH	XKL/XKH SAL8/SAM8 SUL8/ SUM8 SUL7/ SUM7	S08 SA8/SU8 S07/SU7	SCFL SON		SOB8		SMT8 SGT8	SMT8 SGT8
DC-3		XKLD	SOM SCM SCI						
<b>SOLENOID VALVES : high inductive loads</b>									
AC-14 / AC-15	SLA SPA/STA SKA	SLA SPA/STA XKA	S08 SA8/SU8 S07/SU7						
DC-13	SLD SPD/ STDSKD	SLD SPD/STD XKD	SCC SOM						
<b>LIGHTS</b>									
AC-5b	SLA SPA/STA SKA/SKL	SLA SPA/STA XKA/XKL	S08 SA8/SU8 S07/SU7 SF						
DC-6	SLD SPD/STD SKD	SLD SPD/STD XKD	SCC SOM						
<b>CONTACTORS - ELECTROMAGNETS: high inductive loads</b>									
AC-14<72VA	SLA SPA/STA SKA	SLA SPA/STA XKA	S08 SA8/SU8 S07/SU7 SF						
AC-15>72VA	SLA SPA/STA SKA/SKL	SLA SPA/STA XKA/XKL	S08 SA8/SU8 S07/SU7 SF						
DC-13	SLD/SPD STD/SKD	SLD/SPD STD/XKD XKLD	SCC SCM SOM						
DC-14	SLD/SPD STD/SKD	SLD/SPD STD/XKD XKLD	SCC SCM SOM						
<b>PLC INPUTS/OUTPUTS: interfaces, low current</b>									
AC Input									
DC Input									
AC Output	SLA SPA/STA SKA	SLA SPA/STA XKA	SF		XKM			XKM	
DC Output	SLD SPD/ STDSKD	SLD SPD/STD XKD							
<b>TRANSFORMERS: very strong magnetising currents, overvoltages</b>									
AC-6a	SKL/SKH	XKL/XKH	S07/SOP						
<b>CAPACITY (Power factor corrections, Power supplies): strong inrush current</b>									
AC-6b	SKL/SKH	XKL/XKH	S08 SA8/SU8						SMT8 SGT8

# Solid State Relays



Function	DIAGNOSIS / TEMP. REGULATOR				CONTROLLER		REVERSING SWITCH		SOFT STARTERS			
	No. Of poles	4 poles	1 pole - Single Phase	3 poles	1 pole	3 poles	3 poles Three-phase		1 pole Single Phase		3 poles Three-phase	
Assembly type	Screw-in	DIN rail	Screw-in	Screw-in	Screw-in	Screw-in	DIN rail	Screw-in	DIN rail	Screw-in	DIN rail	Screw-in
<b>HEATING ELEMENTS: No inrush current</b>												
AC-1	SCQ SMQR	SILD SUL+ESUC SUL+ECOM	SOD/SOI SU+ESUC SU+ECOM	SMB 8670910	S04 S03 SG4 SG5	SGTA SVTA						
DC-1												
<b>INCANDESCENT LAMPS - INFRARED LIGHTS - INDICATOR LIGHTS: strong inrush currents</b>												
AC-5b	SCQ SMQR				S04 SG4	SVTA			S04	S04	SMCW	SMCV
<b>DISCHARGE LAMPS: strong inrush currents, overvoltages at the turn off</b>												
AC-5a	SCQ SMQR											
<b>MOTORS: strong start currents</b>												
AC-3	SCQ SMQR	SILD SUL+ESUC	SOD SOI SU+ESUC	SMB8670910	S04 SG4	SVTA	XKR	SMR SGR SG9 SV9	S04	S04	SMCW	SMCV
DC-3							XKRD	SGRD				
<b>SOLENOID VALVES : high inductive loads</b>												
AC-14 / AC-15												
DC-13												
<b>LIGHTS</b>												
AC-5b												
DC-6												
<b>CONTACTORS - ELECTROMAGNETS: high inductive loads</b>												
AC-14<72VA												
AC-15>72VA												
DC-13												
DC-14												
<b>PLC INPUTS/OUTPUTS: interfaces, low current</b>												
AC Input												
DC Input												
AC Output							XKR					
DC Output												
<b>TRANSFORMERS: very strong magnetising currents, overvoltages</b>												
AC-6a					S04 SG4	SVTA					SMCW	SMCV
<b>CAPACITY (Power factor corrections, Power supplies): strong inrush current</b>												
AC-6b												



# Solid State Relays

PCB Mount

DIN-Rail Mount

Panel Mount\*

Plug-in Mount\*

- Motor Control (Compressors, conveyors, lifts, etc.)
- ◆ Heat Control (Plastic Molding, Food Equipment, etc.)
- Lighting (Traffic, Entertainment, industrial and commercial fixtures, etc.)
- ★ Energy Control (Data and Communication systems, etc.)

\* Note that we offer DIN-Rail adapters for many of our Panel Mount parts and our Plug-in models

No. of poles	Function	CURRENT (standard industrial load AC-1 / for heavy duty loads, please refer to the data-sheets)								Page
		≤ 4A	≤ 10A	≤ 25A	≤ 35A	≤ 50A	≤ 75A	≤ 95A	≤ 125A	
AC - LINE VOLTAGE 240Vac (≤ 280Vac)	1 ON/OFF RELAY	SLA ●◆□★								14
	1 ON/OFF RELAY	SPA ●◆□★								14
	1 ON/OFF RELAY		XKA ●◆□							15
	1 ON/OFF RELAY		SKA ●◆□							16
	1 ON/OFF RELAY		SKB ◆							16
	1 ON/OFF RELAY			SKL ●□★						16
	1 ON/OFF RELAY			SN8 ●◆□★						17
	1 ON/OFF RELAY					S07 ●□★				19
	1 ON/OFF RELAY			S08 ●□★	S08 ●□★	S08 ●□★	S08 ●□★	S08 ●□★	S08 ●□★	19
	1 ON/OFF RELAY			S09 ◆	S09 ◆	S09 ◆				20
	1 ON/OFF RELAY			SOL9 ◆						20
	1 ON/OFF RELAY				SOR ●◆□★					23
	1 ON/OFF RELAY			SA8 ●□★						25
	1 ON/OFF RELAY			SA9 ◆						25
	1 ON/OFF RELAY			SAL9 ◆						25
	1 ON/OFF RELAY			SU8 ●□★						26
	1 ON/OFF RELAY			SU9 ◆						26
	1 ON/OFF RELAY			SUL8 ●□★						26
	1 ON/OFF RELAY			SUL9 ◆						26
	1 ON/OFF RELAY		SF5 ●◆□★	SF5 ●◆□★						22
	1 ON/OFF RELAY			SCF ●◆□★						22
	1 ON/OFF RELAY		SP78 ●◆□★							22
	2 ON/OFF RELAY			SOB5 ◆	SOB5 ◆					30
	2 ON/OFF RELAY			SOB9 ◆	SOB9 ◆	SOB9 ◆				31
	3 ON/OFF RELAY			SHT ●◆□★						17
	3 ON/OFF RELAY			SGT9 ◆	SGT9 ◆	SGT9 ◆	SGT9 ◆			35
	4 ON/OFF RELAY			SCQ ●◆□★						36
	4 ON/OFF RELAY			SMQR ●◆□★						36
	1 DIAGNOSTIC					SILD ●◆□★				29
	1 DIAGNOSTIC					SOD ◆□★	SOD ◆□★		SOD ◆□★	29
	1 EMC OPTIMIZED			SCFL ●◆□★						21
	1 EMC OPTIMIZED					SON ●◆□★				21
	1 CONTROLLER				SG4 ●◆□★	SG4 ●◆□★	SG4 ●◆□★	SG4 ●◆□★		40
1 CONTROLLER					S04 ◆				40	
1 CONTROLLER						S03 ◆			41	
1 CONTROLLER		SG5 ◆		SG5 ◆					42	

# Solid State Relays



No. of poles	Function	CURRENT (standard industrial load AC-1 / for heavy duty loads, please refer to the data-sheets)							Page		
		≤ 4A	≤ 10A	≤ 25A	≤ 35A	≤ 50A	≤ 75A	≤ 95A		≤ 125A	
AC - LINE VOLTAGE 480Vac (≤ 520Vac)	1 ON/OFF RELAY		XKA ●◆□★						15		
	1 ON/OFF RELAY		SKA ●◆□★						16		
	1 ON/OFF RELAY		SKB ◆						16		
	1 ON/OFF RELAY			SKL ●□★					16		
	1 ON/OFF RELAY				S07 ●□★	S07 ●□★	S07 ●□★	S07 ●□★	S07 ●□★	19	
	1 ON/OFF RELAY				S08 ●□★	S08 ●□★	S08 ●□★	S08 ●□★	S08 ●□★	19	
	1 ON/OFF RELAY				S09 ◆	S09 ◆	S09 ◆	S09 ◆		20	
	1 ON/OFF RELAY					SOL9 ◆				20	
	1 ON/OFF RELAY					SU7 ●□★				26	
	1 ON/OFF RELAY					SU8 ●□★	SU8 ●□★			26	
	1 ON/OFF RELAY				SUL7 ●□★					26	
	1 ON/OFF RELAY				SUL8 ●□★					26	
	1 ON/OFF RELAY					SUM9 ◆				26	
	2 ON/OFF RELAY				SOB5 ◆					30	
	2 ON/OFF RELAY				SOB7 ●□★	SOB7 ●□★	SOB7 ●□★			31	
	2 ON/OFF RELAY						SOB8 ●□★			31	
	3 ON/OFF RELAY				SMB8 ●□★					34	
	3 ON/OFF RELAY			SMT8 ●□★						34	
	3 ON/OFF RELAY			SMT8 ●□★						34	
	3 ON/OFF RELAY					SGT7 ●□★			SGT7 ●□★	35	
	3 ON/OFF RELAY				SGT8 ●□★	SGT8 ●□★	SGT8 ●□★		SGT8 ●□★	35	
	3 ON/OFF RELAY			SGT8 ●□★		SGT8 ●□★				35	
	3 ON/OFF RELAY			SGT9 ◆					SGT9 ◆	35	
	1 DIAGNOSTIC					SOD ●◆□★	SOD ●◆□★			29	
	1 EMC OPTIMIZED			SCFL ●◆□★						21	
	1 EMC OPTIMIZED					SON ●◆□★	SON ●◆□★			21	
	1 CONTROLLER					S04 ◆	S04 ◆	S04 ◆	S04 ◆	40	
	3 CONTROLLER					SVTA ●□★		SVTA ●□★	SVTA ●□★	43	
	3 CONTROLLER					SGTA ◆				43	
	3 REVERSING SWITCH			SMR ●						37	
	3 REVERSING SWITCH			SG9 ●						37	
	AC - LINE VOLTAGE 600Vac (≤ 690Vac)	1 ON/OFF RELAY		SKB ◆						16	
		1 ON/OFF RELAY			SKL ●□★					16	
		1 ON/OFF RELAY							S07 ●□★	19	
		1 ON/OFF RELAY					S08 ●□★	S08 ●□★	S08 ●□★	S08 ●□★	19
		1 ON/OFF RELAY							S09 ◆	20	
		1 ON/OFF RELAY					SOL8 ●◆□★			SOL8 ●◆□★	20
1 ON/OFF RELAY						SOR ●◆□★	SOR ●◆□★			23	
1 ON/OFF RELAY					SA9 ◆	SA9 ◆				25	
1 ON/OFF RELAY				SAL9 ◆	SAL9 ◆					25	
1 ON/OFF RELAY					SAM9 ◆	SAM9 ◆				25	
1 ON/OFF RELAY					SU9 ◆	SU9 ◆	SU9 ◆			26	
1 ON/OFF RELAY					SUL9 ◆					26	
1 ON/OFF RELAY				SCF ●◆□★						22	
2 ON/OFF RELAY				SOB5 ◆						30	
2 ON/OFF RELAY						SOB6 ◆				30	
2 ON/OFF RELAY						SOB8 ●□★	SOB8 ●□★			31	
2 ON/OFF RELAY				SOB9 ◆	SOB9 ◆	SOB9 ◆	SOB9 ◆			31	
2 ON/OFF RELAY					SOBR9 ◆	SOBR9 ◆				32	
3 ON/OFF RELAY					SMB8 ●◆□★					34	
3 ON/OFF RELAY						SGB8 ●□★	SGB8 ●□★	SGB8 ●□★	SGB8 ●□★	34	
3 ON/OFF RELAY						SGT8 ●□★	SGT8 ●□★			35	
3 ON/OFF RELAY					SGT9 ◆	SGT9 ◆	SGT9 ◆			35	
1 DIAGNOSTIC						SOI ●◆□★				29	



# Interface Relays

**100% COMPATIBLE**  
with electromechanical  
relays

## SL

### Miniature size

SLA/SLD solid state relays are 100% compatible with 5 mm wide electromechanical relays. They can be soldered directly on to PCBs or plugged into all types of DIN rail standard bases. These relays can switch all types of loads and they can withstand significant current surges from loads in electrovalves, motors, contactor coils, LEDs, etc. The switching power for SLA relays is 2A/280VAC and 2.5A/60VDC or 4A/24VDC for SLD relays.

You can find more information on the standards applicable to our products by referring to our technical datasheets.



	Product reference	Max. switching current	Switching voltage	Control voltage	Protec. / Specifications
AC	SLA03220	2A	12-280VAC	18-32VDC	RC / AC Random output
	SLA03220L	2A	12-280VAC	18-32VDC	RC / AC Random output*
DC	SLD01205	4A	0-32VDC	3-10VDC	TVS / DC output
	SLD02205	4A	0-32VDC	7-20VDC	TVS / DC output
	SLD03205	4A	0-32VDC	18-32VDC	TVS / DC output
	SLD03210	2.5A	0-60VDC	18-32VDC	TVS / DC output



SLA / SLD  
● Dim. 28 x 5 x 15 mm  
(1.10 x 0.20 x 0.59 in)

\*Very low leakage current model

Other miniature solid state relay options are available on request.

### Accessory

Product reference	Specifications
ESD01000	SLA/SLD base for PCB for one relay



## SP / ST

### Standard size

AC and DC range from 1 to 5A, with built-in protection (VDR or Transil), available in heights of 15.7 mm (ST Series) and 25.4 mm (SP Series).

You can find more information on the standards applicable to our products by referring to our technical datasheets.



	Product reference	Max. switching current	Switching voltage	Control voltage	Protec. / Specifications
AC	SPA01420	4A	12-275VAC	4-16VDC	VDR / AC zero-cross output
	SPA07420	4A	12-275VAC	12-30VAC/DC	VDR / AC zero-cross output
	STA07220	2A	12-275VAC	12-30VAC/DC	VDR / AC zero-cross output
DC	SPD03505	5A	0-30VDC	10-30VDC	TVS / DC output
	SPD07505	5A	0-30VDC	12-30VAC/DC	TVS / DC output
	STD03205	2.5A	0-30VDC	10-30VDC	TVS / DC output
	STD03505	5A	0-30VDC	10-30VDC	TVS / DC output
	STD03510	5A	0-68VDC	10-30VDC	TVS / DC output
	STD07205	2.5A	0-30VDC	12-30VAC/DC	TVS / DC output



SPA / SPD  
● Dim. 29 x 12.7 x 25.4 mm  
(1.14 x 0.5 x 0.94 in)

On request, our STD and SPD modules can be modified with a higher output voltage (100VDC). Other control voltages are available on request.



### Accessory

Product reference	Specifications
ESD05000	SP/ST base for DIN rail for one relay



STA / STD  
● Dim. 29 x 12.7 x 15.7 mm  
(1.14 x 0.47 x 0.59 in)





## DIN-rail mounting

Interface relays to control loads such as resistors, LEDs, electrovalves, transformers and power contactor coils. They can also be supplied as dedicated motor control variants with 2 and 3-phase switching and motor rotation reversal. They are DIN-rail mounted and fitted with LEDs.

You can find more information on the standards applicable to our products by referring to our technical datasheets.



	Product reference	Max. switching current	Switching voltage	Control voltage	Protec.	Specifications
AC	XKA20420	5A	12-275VAC	6-30VDC	VDR	1 pole zero-cross
	XKA20420D	5A	12-275VAC	6-30VDC	VDR	Zero-cross / Removable terminals
	XKA20420R	5A	12-275VAC	6-30VDC	VDR	Zero-cross / Removable spring terminals
	XKA20421	5A	12-275VAC	5-30VDC	VDR	1 pole random
	XKA70420	5A	12-275VAC	15-30VAC/DC	VDR	1 pole zero-cross
	XKA70440	5A	12-440VAC	12-30VAC/8.5-30VDC	VDR	1 pole zero-cross
	XKA90440	5A	12-440VAC	150-240VAC/DC	VDR	1 pole zero-cross
	XKH20120	10A@40°C	12-400VAC	10-32VDC		1 pole zero-cross / with integrated heatsink
DC	XKD10120	1A	2-220VDC	5-30VDC	diode	BIPOLAR Technology
	XKD10306	3A	2-60VDC	5-30VDC	diode	BIPOLAR Technology
	XKD11306D	3A	2-60VDC	3-30VDC	diode	BIPOLAR Technology / Removable terminals
	XKD70306	3A	2-60VDC	10-30VAC/DC	diode	BIPOLAR Technology
	XKD90306	3A	2-60VDC	90-240VAC/DC	diode	BIPOLAR Technology
	XKLD0020	4A	10-100VDC	18-32VDC	TVS + diode + fuse	1 pole / Diag. Output 1-32VDC 100mA
	XKLD31006	10A	10-40VDC	10-30VDC	VDR	MOSFET Technology



### XKA / XKD

- Dim. 12.2 x 76.4 x 53 mm (0.47 x 2.99 x 2.09 in) or Dim. 17.2 x 76.4 x 53 mm (0.67 x 2.99 x 2.09 in) (depending on models, please see technical data-sheet)

### XKH

- Dim. 25 x 76.4 x 65mm (0.98 x 2.99 x 2.56 in)



- Dim. 36 x 78 x 61mm (1.42 x 3.07 x 2.40 in)

**XKLD0020** includes all the built-in protective devices and is designed for inductive loads with high switching frequencies:

- ▶ Diagnostic status output (voltage-free)
- ▶ Control visualisation via a green LED
- ▶ Output DC visualisation via a red LED
- ▶ Built-in surge arrester
- ▶ Built-in flyback diode
- ▶ Fuse included for circuit protection (installation protection)



## Motor control

You can find more information on the standards applicable to our products by referring to our technical datasheets.



	Product reference	Max. switching current	Switching voltage	Control voltage	Protec.	Specifications
MOTOR CONTROL	XKM22440	4A AC-1 / 2.5A AC-3	24-460VAC	15-40VDC	VDR	2 poles motor switching control
	XKR24440	4A AC-1 / 2.5A AC-3	24-460VAC	15-40VDC	VDR	AC motor change-over control
	XKRD30506	5A-DC	7-36VDC	7-30VDC	diode	DC motor change-over control



### XKM

- Dim. 36 x 78 x 61mm (0.98 x 2.99 x 2.09 in)



### XKR / XKRD

- Dim. 36 x 78 x 61mm (2.28 x 2.99 x 2.09 in)

This ready-to-use, DIN-rail mounted **XKRD30506** module consists of four solid state relays. It is wired as an inverter which can be used to change the direction of a DC motor (100W @ 24Vdc).





# Relays for printed circuits

## SK5

### Normally closed contact

You can find more information on the standards applicable to our products by referring to our technical datasheets.



● Dim. 40 x 11 x 21 mm  
(1.57 x 0.43 x 0.83 in)

Solid State Relays are usually designed to be "Normally Open – NO" devices. However, "Normally Closed – NC" Solid State Relay solutions are also possible for both AC and DC switching. A NO Solid State Relay allows the output current to flow when there is a voltage present on the control input. An NC Solid State Relay has the inverse operation, i.e. the output contact(s) are initially closed and they open when a control signal is applied.

Product reference	Max. switching current	Switching voltage	Control voltage	LED	I <sup>2</sup> t	Protec.	Specifications
SK541101	2.5A	24-280VAC	3-30VDC	non	50A <sup>2</sup> s	–	Zero-cross / Normally closed

## SKA / SKB

You can find more information on the standards applicable to our products by referring to our technical datasheets.



● Dim. 43.2 x 10.2 x 25.4 mm  
(1.69 x 0.39 x 0.98 in)

The printed circuit SK range is available in different models: SKA/SKB (AC output) or SKD/SKLD (DC output – see pages 44-45).

- ▶ SKA can switch currents up to 5A, switch voltages of 230 or 400VAC and it has built-in voltage protection. This range is ideal for motor control applications, electrovalves and resistive loads.
- ▶ SKB can switch currents up to 5A, switch voltages of 230 or 400VAC and is only used for controlling resistive loads.

Product reference	Max. switching current	Switching voltage	Control voltage	LED	I <sup>2</sup> t	Protec.	Specifications
SKA10420	5A	12-275VAC	2.5-10VDC	no	50A <sup>2</sup> s	VDR	Zero-cross / most types of loads
SKA10440	5A	12-460VAC	2.5-10VDC	no	50A <sup>2</sup> s	VDR	Zero-cross / most types of loads
SKA11440	5A	12-460VAC	3-10VDC	yes	50A <sup>2</sup> s	VDR	Zero-cross / most types of loads
SKA20420	5A	12-275VAC	4-30VDC	no	50A <sup>2</sup> s	VDR	Zero-cross / most types of loads
SKA20421	5A	12-275VAC	3-30VDC	no	50A <sup>2</sup> s	VDR	Random / most types of loads
SKA20440	5A	12-460VAC	4-30VDC	no	50A <sup>2</sup> s	VDR	Zero-cross / most types of loads
SKA20441	5A	12-460VAC	3-30VDC	no	50A <sup>2</sup> s	VDR	Random / most types of loads
SKA20460	5A	24-600VAC	5-30VDC	no	72A <sup>2</sup> s	–	Zero-cross / most types of loads
SKA21441	5A	12-460VAC	7-30VDC	yes	50A <sup>2</sup> s	VDR	Random / most types of loads
SKB10420	5A	12-280VAC	3-10VDC	no	50A <sup>2</sup> s	–	Zero-cross / resistive loads
SKB10440	5A	24-600VAC	3.7-10VDC	no	72A <sup>2</sup> s	–	Zero-cross / resistive loads
SKB20420	5A	12-280VAC	8-30VDC	no	50A <sup>2</sup> s	–	Zero-cross / resistive loads

## SKL

The SKL Series is manufactured with a ceramic substrate which allows the relay to be mounted on a heatsink for maximum thermal dissipation. The power element of our SKL uses TMS<sup>2</sup> technology. This design reduces thermal stress and considerably improves the life expectancy of the product. The SKL Series is available with current ratings from 16A to 75A and is ideal for motor or lamp control with high inrush currents (I<sup>2</sup>t up to 5000 A<sup>2</sup>s) as well as heating applications. This product range can easily be protected against short circuits by adding micro circuit breakers in the system design.

Product reference	Thyristor rating	Max. switching current with heatsink	Switching voltage	Control voltage	I <sup>2</sup> t	Specifications
SKL10120	16A	16A	12-280VAC	4-14VDC	128A <sup>2</sup> s	Zero-cross
SKL10220	25A	21A	12-280VAC	4-14VDC	312A <sup>2</sup> s	Zero-cross
SKL10240	25A	22A	24-600VAC	4-14VDC	450A <sup>2</sup> s	Zero-cross
SKL10260	40A	22A	24-690VAC	4-14VDC	1150A <sup>2</sup> s	Zero-cross
SKL10521	50A	27A	12-280VAC	3-14VDC	2450A <sup>2</sup> s	Random
SKL10540	50A	27A	24-600VAC	4-14VDC	1800A <sup>2</sup> s	Zero-cross
SKL10560	50A	27A	24-690VAC	4-14VDC	1800A <sup>2</sup> s	Zero-cross
SKL20120	16A	16A	12-280VAC	8-32VDC	128A <sup>2</sup> s	Zero-cross
SKL20220	25A	21A	12-280VAC	8-32VDC	312A <sup>2</sup> s	Zero-cross
SKL20240	25A	22A	24-600VAC	8-32VDC	450A <sup>2</sup> s	Zero-cross
SKL20241	25A	22A	24-600VAC	8-32VDC	450A <sup>2</sup> s	Random
SKL20740	75A	30A	24-600VAC	8-32VDC	5000A <sup>2</sup> s	Zero-cross

You can find more information on the standards applicable to our products by referring to our technical datasheets.



● Dim. 43.2 x 6.3 x 24.5 mm  
(1.69 x 0.24 x 0.94 in)

See DC output models pages 44-45

# Relays for printed circuits



## SKH

You can find more information on the standards applicable to our products by referring to our technical datasheets.



SKH is a "ready to use" range of solid state relays for printed circuits. Each relay has a built-in heatsink.

Product reference	Max. switching current (at 40°C)	Max. switching current with ventilation	Switching voltage	Control voltage	I <sup>2</sup> t
SKH10120	8A	16A	12-280VAC	4-14VDC	128A <sup>2</sup> s
SKH10240	9A	25A	24-600VAC	4-14VDC	450A <sup>2</sup> s
SKH20120	8A	16A	12-280VAC	8-32VDC	128A <sup>2</sup> s
SKH20240	9A	25A	24-600VAC	8-32VDC	450A <sup>2</sup> s

Other models are available on request.

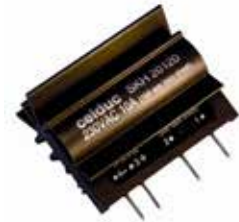

● Dim. 43.6 x 22 x 35.7 mm (1.69 x 0.87 x 1.38 in)

## SN8

You can find more information on the standards applicable to our products by referring to our technical datasheets.



This relay is designed for printed circuits and, when fitted with a suitable heatsink, can control heavy loads in an ultra-miniature, physically compact package.

Product reference	Max. switching current	Switching voltage	Control voltage	I <sup>2</sup> t
SN842100	25A	24-280VAC	3.5-15VDC	260A <sup>2</sup> s

Other models are available on request (voltages, currents and types of controls).



● Dim. 35.05 x 12.7 x 28.32 mm (1.38 x 0.47 x 1.10 in)

## SHT

You can find more information on the standards applicable to our products by referring to our technical datasheets.



Three-phase solid state relay in a single low profile package for printed circuits. This relay is designed for PCB applications. Complete with a heatsink, it provides control of medium power in three-phase networks.

Product reference	Max. switching current	Switching voltage	Control voltage	I <sup>2</sup> t
SHT842300	3x25A	24-280VAC	10-30VDC	260A <sup>2</sup> s

Other models are available on request.



● Dim. 81.28 x 8.26 x 27.69 mm (3.19 x 0.31 x 1.06 in)

## Applications

Electrovalves, LEDs, contactors  
**Id = 1.4xIn** SKA

Heating elements  
**Id = In** SKB / SKL

Infrared lamps or lighting  
**Id = 10xIn** SKL / SKH

Motors  
**Id = 8xIn** SKL / SKH

Id = Starting current | In = Nominal current



# Single phase Solid State Relays

All our solid state relays are fitted with back-to-back thyristors and use fourth generation TMS<sup>2</sup> technology with a very long service life compared to the majority of products on the market (application note available on request).



## okpac<sup>®</sup>

### Innovation, Performance & Design !

- ▶ Multiple, simple and fast connections
- ▶ Removable IP20
- ▶ A single screwdriver for both the output and input
- ▶ Attached to a metal baseplate, not plastic
- ▶ Removable control terminals
- ▶ SSR, mains and load status diagnostics.
- ▶ Output voltage from 24 to 690 VAC (600V-1200V-1600V peak)
- ▶ Very low zero-crossing level
- ▶ Large range of regulated AC and DC input voltage
- ▶ LEDs
- ▶ EMC compliant for the industrial environment
- ▶ UL/cUL, VDE, IEC/EN60947-4-3, CE marking
- ▶ I<sub>tsm</sub> up to 2 000A and I<sup>2</sup>t > 20 000A<sup>2</sup>s
- ▶ Can be combined with a circuit breaker for additional protection.

### Multiple, simple and fast connections

#### CONNECTION on the power side



**Direct connection by wire or end fitting**  
 2 x 6 mm<sup>2</sup> (AWG10) fine strand i.e. 32A  
 2 x 10 mm<sup>2</sup> (AWG8) solid i.e. 50A



**With tubular cable lugs**  
 Up to 50mm<sup>2</sup> (AWG1) with or without adjustment i.e. 150A



**Screw with lock washers**  
 Improved shock and vibration resistance

#### CONNECTION on the control side



**Using screws**  
 (S07 / S08 / S09 / SOL)



**Using pluggable spring connector technology (SOR)**

### REMINDER

- S07 / SOL7 ▶ Random for inductive and motor loads
- S08 / SOL8 ▶ Zero-cross for all kinds of loads / heavy duty loads
- S09 / SOL9 ▶ Zero-cross for standard industrial loads / resistive loads AC-1 (AC-51)

# Single phase Solid State Relays



# okpac®



celduc® supplies "ready to use" solutions with built-in heatsinks.

## SO7 Random

Typical applications: AC-3 motor loads and strong inductive loads.  
The SO7 range provides instant switching (immediate/random) with voltage protection on input (Transil) and output (RC and VDR) depending on the specific part.

Product reference	Max. switching current	Switching voltage	Peak voltage	Control voltage	I <sup>2</sup> t	Protec.
SO745090	50A	12-275VAC	600V	3-32VDC	2 800A <sup>2</sup> s	RC-VDR
SO763090	35A	24-510VAC	1200V	3.5-32VDC	1 250A <sup>2</sup> s	RC-VDR
SO765090	50A	24-510VAC	1200V	3.5-32VDC	2 800A <sup>2</sup> s	RC-VDR
SO765980	50A	24-600VAC	1200V	20-365VAC/DC	2 800A <sup>2</sup> s	RC
SO767090	75A	24-510VAC	1200V	3.5-32VDC	7 200A <sup>2</sup> s	RC-VDR
SO768090	95A	24-510VAC	1200V	3.5-32VDC	16 200A <sup>2</sup> s	RC-VDR
SO769090	130A	24-510VAC	1200V	3.5-32VDC	22 000A <sup>2</sup> s	RC-VDR
SO789060	130A	24-690VAC	1600V	3.5-32VDC	22 000A <sup>2</sup> s	-



You can find more information on the standards applicable to our products by referring to our technical datasheets.



● Dim. 45 x 58.5 x 30 mm  
(1.77 x 2.28 x 1.18 in)

All these products must be mounted on heatsinks in order to reach nominal performance.

## SO8 Zero-cross

- SO8 range is designed for most types of loads
- ▶ Zero cross with low zero-crossing level (<12V)
  - ▶ Voltage protection on input (transil) and on output (VDR or TVS depending on the part) with very high immunity according to IEC/ EN61000-4-4
  - ▶ Removable IP20 flaps over both input and output terminals
  - ▶ Control current < 13mA for all the voltage range at any operating temperature
  - ▶ LED input status indicator.

Product reference	Max. switching current	Switching voltage	Peak voltage	Control voltage	I <sup>2</sup> t	Protec.
SO842074	25A	12-275VAC	600V	3-32VDC	600A <sup>2</sup> s	VDR
SO842974	25A	12-275VAC	600V	20-265VAC/DC	600A <sup>2</sup> s	VDR
SO843070	35A	12-275VAC	600V	3-32VDC	1 250A <sup>2</sup> s	VDR
SO843970	35A	12-275VAC	600V	20-265VAC/DC	1 250A <sup>2</sup> s	VDR
SO845070	50A	12-275VAC	600V	3-32VDC	2 800A <sup>2</sup> s	VDR
SO845970	50A	12-275VAC	600V	20-265VAC/DC	2 800A <sup>2</sup> s	VDR
SO848070	95A	12-275VAC	600V	3-32VDC	16 200A <sup>2</sup> s	VDR
SO849070	130A	12-275VAC	600V	3-32VDC	22 000A <sup>2</sup> s	VDR
SO863070	35A	24-510VAC	1200V	3.5-32VDC	1 250A <sup>2</sup> s	VDR
SO863970	35A	24-510VAC	1200V	20-265VAC/DC	1 250A <sup>2</sup> s	VDR
SO865070	50A	24-510VAC	1200V	3.5-32VDC	2 800A <sup>2</sup> s	VDR
SO865970	50A	24-510VAC	1200V	20-265VAC/DC	2 800A <sup>2</sup> s	VDR
SO867070	75A	24-510VAC	1200V	3.5-32VDC	7 200A <sup>2</sup> s	VDR
SO867970	75A	24-510VAC	1200V	20-265VAC/DC	7 200A <sup>2</sup> s	VDR
SO868070	95A	24-510VAC	1200V	3.5-32VDC	16 200A <sup>2</sup> s	VDR
SO868970	95A	24-510VAC	1200V	20-265VAC/DC	16 200A <sup>2</sup> s	VDR
SO869070	130A	24-510VAC	1200V	3.5-32VDC	22 000A <sup>2</sup> s	VDR
SO869970	130A	24-510VAC	1200V	20-265VAC/DC	22 000A <sup>2</sup> s	VDR



You can find more information on the standards applicable to our products by referring to our technical datasheets.



● Dim. 45 x 58.5 x 30 mm  
(1.77 x 2.28 x 1.18 in)

HIGH VOLTAGE RELAYS	Product reference	Max. switching current	Switching voltage	Peak voltage	Control voltage	I <sup>2</sup> t	Protec.
	SO885060	50A	24-690VAC	1600V	3.5-32VDC	2 800A <sup>2</sup> s	-
	SO885960	50A	24-690VAC	1600V	20-265VAC/DC	2 800A <sup>2</sup> s	-
	SO887040	75A	24-690VAC	1600V	3.5-32VDC	7 200A <sup>2</sup> s	TVS
	SO887060	75A	24-690VAC	1600V	3.5-32VDC	7 200A <sup>2</sup> s	-
	SO887940	75A	24-690VAC	1600V	20-265VAC/DC	7 200A <sup>2</sup> s	TVS
	SO888060	95A	24-690VAC	1600V	3.5-32VDC	16 200A <sup>2</sup> s	-
SO889060	130A	24-690VAC	1600V	3.5-32VDC	22 000A <sup>2</sup> s	-	





# Single phase Solid State Relays

## SO9 Zero-cross

For standard industrial loads / Resistive loads AC-1  
 ▶ LED input status indicator ▶ IP20 flaps



You can find more information on the standards applicable to our products by referring to our technical datasheets.



• Dim. 45 x 58.5 x 30 mm  
(1.77 x 2.28 x 1.18 in)

Product reference	Max. switching current	Switching voltage	Peak voltage	Control voltage	I <sup>2</sup> t	Regulated control current	Specifications / Protec.
SO941440	12A	12-280VAC	600V	3-32VDC	128A <sup>2</sup> s	yes	Control current <13mA / TVS
SO941460	12A	12-280VAC	600V	3-32VDC	128A <sup>2</sup> s	yes	Control current <13mA
SO941940	12A	12-280VAC	600V	18-280VAC/DC	128A <sup>2</sup> s	yes	Control current <13mA / TVS
SO942440	25A	12-280VAC	600V	3-32VDC	600A <sup>2</sup> s	yes	TVS
SO942460	25A	12-280VAC	600V	3-32VDC	600A <sup>2</sup> s	yes	Control current <13mA
SO942470	25A	12-275VAC	600V	3-32VDC	600A <sup>2</sup> s	yes	VDR
SO942860	25A	12-280VAC	600V	15-32VAC/10-30VDC	600A <sup>2</sup> s	no	With simplified input
SO942940	25A	12-280VAC	600V	18-280VAC/DC	600A <sup>2</sup> s	yes	Control current <13mA / TVS
SO942960	25A	12-280VAC	600V	185-265VAC/DC	600A <sup>2</sup> s	no	With simplified input
SO943460	40A	12-280VAC	600V	3-32VDC	1 250A <sup>2</sup> s	yes	Control current <13mA
SO945460	60A	12-280VAC	600V	3-32VDC	2 800A <sup>2</sup> s	yes	Control current <13mA
SO963440	40A	24-600VAC	1200V	3.5-32VDC	1 250A <sup>2</sup> s	yes	Control current <13mA / TVS
SO963460	40A	24-600VAC	1200V	3.5-32VDC	1 250A <sup>2</sup> s	yes	Control current <13mA
SO96346H	35A	24-600VAC	1200V	3.5-32VDC	882A <sup>2</sup> s	yes	Control current <13mA
SO96386H	35A	24-600VAC	1200V	15-32VAC	882A <sup>2</sup> s	yes	Control current <13mA
SO963940	40A	24-600VAC	1200V	18-280VAC/DC	882A <sup>2</sup> s	yes	Control current <13mA / TVS
SO965030-HE	50A	24-600VAC	1200V	3.5-32VDC	1 680A <sup>2</sup> s	yes	Control current <13mA
SO965440	60A	24-600VAC	1200V	3.5-32VDC	2 800A <sup>2</sup> s	yes	Control current <13mA / TVS
SO965460	60A	24-600VAC	1200V	3.5-32VDC	2 800A <sup>2</sup> s	yes	Control current <13mA
SO96546H	50A	24-600VAC	1200V	3.5-32VDC	1 680A <sup>2</sup> s	yes	Control current <13mA
SO96546T	60A	24-600VAC	1200V	3.5-32VDC	2 800A <sup>2</sup> s	yes	Thermal Pad mounted
SO965940	60A	24-600VAC	1200V	18-280VAC/DC	2 800A <sup>2</sup> s	yes	Control current <13mA / TVS
SO967440	90A	24-600VAC	1200V	3.5-32VDC	7 200A <sup>2</sup> s	yes	Control current <13mA / TVS
SO967460	90A	24-600VAC	1200V	3.5-32VDC	7 200A <sup>2</sup> s	yes	Control current <13mA
SO967860	90A	24-600VAC	1200V	15-32VAC	7 200A <sup>2</sup> s	no	With simplified input
SO967940	90A	24-600VAC	1200V	18-280VAC/DC	7 200A <sup>2</sup> s	yes	Control current <13mA / TVS
SO967960	90A	24-600VAC	1200V	20-265VAC/DC	7 200A <sup>2</sup> s	yes	Consumption <13mA
SO96846T	95A	24-600VAC	1200V	3.5-32VDC	11 250A <sup>2</sup> s	yes	Thermal Pad mounted
SO968470	95A	24-510VAC	950V	3.5-32VDC	11 250A <sup>2</sup> s	yes	Control current <13mA / VDR
SO969440	130A	24-600VAC	1200V	3.5-32VDC	22 000A <sup>2</sup> s	yes	Control current <13mA / TVS
SO969940	130A	24-600VAC	1200V	18-280VAC/DC	22 000A <sup>2</sup> s	yes	Control current <13mA / TVS

All these products must be mounted on heatsinks in order to reach nominal performance.

## SOL flatpac® Low profile (h=16,3mm)



You can find more information on the standards applicable to our products by referring to our technical datasheets.



• Dim. 45 x 58.5 x 16.3 mm  
(1.77 x 2.28 x 0.63 in)

These flatpac® relays are mainly designed for applications where a PCB is usually installed on the relay's control side. This product can also be used for applications where the wires are on the power side.

	Product reference	Max. switching current	Switching voltage	Peak voltage	Control voltage	I <sup>2</sup> t	Specifications
HIGH VOLTAGE RELAYS	SOL885060	50A	24-690VAC	1600V	3.5-32VDC	2 800A <sup>2</sup> s	Zero-cross / most types of loads
	SOL889060	130A	24-690VAC	1600V	3.5-32VDC	22 000A <sup>2</sup> s	Zero-cross / most types of loads
	SOL942460	25A	12-280VAC	600V	3-32VDC	600A <sup>2</sup> s	Zero-cross / resistive loads
	SOL942960	25A	12-280VAC	600V	185-265VAC/DC	600A <sup>2</sup> s	Zero-cross / resistive loads
	SOL965460	50A	24-600VAC	1200V	3.5-32VDC	2 800A <sup>2</sup> s	Zero-cross / resistive loads

All these products must be mounted on heatsinks in order to reach nominal performance.

# Single phase Solid State Relays



## SOP

### Starting transformer

SOP relays are used for primary transformer inrush currents and all saturable inductive loads in order to avoid magnetizing current peaks (application note available on request).

You can find more information on the standards applicable to our products by referring to our technical datasheets.



• Dim. 45 x 58.5 x 30 mm  
(1.77 x 2.28 x 1.18 in)

Product reference	Thyristor rating	Max. switching current AC-6a	Switching voltage	Peak voltage	Control voltage	I <sup>2t</sup>	Specifications
SOP65070	60A	9A	100-480VAC	1200V	5.5-32VDC	2 800A <sup>2</sup> s	Peak starting
SOP69070	130A	32A	100-480VAC	1200V	5.5-32VDC	20 000A <sup>2</sup> s	Peak starting

All these products must be mounted on heatsinks in order to reach nominal performance

## EMC optimized (low electromagnetic emission – low RFI)

These relays are designed for use in applications where low electromagnetic emission is essential: household and electrical appliances, information technology and medical equipment. The range complies with the EN 50081-1 standard (Electromagnetic compatibility. Generic emission standard. Residential, commercial and light industry).

## SON

### With screw terminals

You can find more information on the standards applicable to our products by referring to our technical datasheets.



Product reference	Max. switching current	Switching voltage	Peak voltage	Control voltage	I <sup>2t</sup>
SON845040	50A	40-260VAC	600V	6-32VDC	2 800A <sup>2</sup> s
SON865040	50A	50-480VAC	1200V	6-32VDC	2 800A <sup>2</sup> s
SON867040	75A	50-480VAC	1200V	6-32VDC	7 200A <sup>2</sup> s

All these products must be mounted on heatsinks in order to reach nominal performance



• Dim. 45 x 58.5 x 30 mm  
(1.77 x 2.28 x 1.18 in)

## SCFL

### With FASTON Terminals

You can find more information on the standards applicable to our products by referring to our technical datasheets.



Product reference	Max. switching current	Switching voltage	Peak voltage	Control voltage	I <sup>2t</sup>
SCFL42100	25A	12-280VAC	600V	4-30VDC	312A <sup>2</sup> s
SCFL62100	25A	24-440VAC	1200V	5-30VDC	312A <sup>2</sup> s

All these products must be mounted on heatsinks in order to reach nominal performance.



• Dim. 44.5 x 58 x 33 mm  
(1.73 x 2.28 x 1.30 in)



# Single phase Solid State Relays

## SSR with "FASTON" terminals for fast connections!

Solid State Relays with "FASTON" terminals are ideal for the food and beverage industry for currents less than 20A. celduc® relays offers a wide range of single phase products with "FASTON" terminals, and also two-phase (see page 30) and four-leg power SSRs (see SMQR and SCQ ranges page 36).

### SF

You can find more information on the standards applicable to our products by referring to our technical datasheets.



Miniature relays available with "FASTON" terminals or with pins for printed circuits.

Product reference	Max. switching current	Switching voltage	Control voltage	Specifications
SF541310	12A	12-280VAC	4-30VDC	Zero-cross, "FASTON" terminals
SF542310	12A	12-280VAC	4-30VDC	Zero-cross, PCB terminals
SF546310	25A	12-280VAC	4-30VDC	Zero-cross, "FASTON" terminals

All these products must be mounted on heatsinks in order to reach nominal performance.



• Dim. 21 x 35.5 x 15 mm (0.83 x 1.38 x 0.59 in)

### SCF

You can find more information on the standards applicable to our products by referring to our technical datasheets.



These relays are designed to control resistive loads.

Product reference	Max. switching current	Switching voltage	Peak voltage	Control voltage	LED	I <sup>2</sup> t	Protec.
SCF42160	25A	12-280VAC	600V	4-30VDC	yes	312A <sup>2</sup> s	-
SCF42324	25A	12-275VAC	600V	12-30VDC	no	312A <sup>2</sup> s	VDR
SCF62160	25A	24-600VAC	1200V	5-30VDC	yes	265A <sup>2</sup> s	-

All these products must be mounted on heatsinks in order to reach nominal performance.



• Dim. 44.5 x 58 x 33 mm (1.73 x 2.28 x 1.30 in)

### SP7 / SP8

With its high immunity components, built-in overvoltage protection combined with 800 V<sub>peak</sub> power elements, these relays can be used with any type of load, such as heating or controlling single phase asynchronous motors. This product range is ideal for the food and beverage industry.

You can find more information on the standards applicable to our products by referring to our technical datasheets.



• Dim. 38 x 66.8 x 22 mm (1.50 x 2.60 x 0.87 in)

Product reference	Thyristor rating	Max. switching current AC-1	Switching voltage	Peak voltage	Control voltage	I <sup>2</sup> t	Specifications
SP752120	25A	12A	12-280VAC	800V	3-32VDC	340A <sup>2</sup> s	Random / VDR
SP852120	25A	12A	12-280VAC	800V	4-32VDC	340A <sup>2</sup> s	Zero-cross / VDR

All these products must be mounted on heatsinks in order to reach nominal performance.



# Single phase Solid State Relays



**NEW**

## Solid State Relays with push-in spring terminals

Fast wiring, even in tight spaces !

Easy to use and requiring no special tools, this connection technology is perfect for compact installations where you need **fast and safe wiring**.



### STRONG

Push-in connections are strong and reliable.



### FLEXIBLE

Push-in connections are suitable for various types of conductors : solid conductors, stranded conductors, and for fine-stranded conductors with crimped-on ferrules.



### FAST

- ▶ Quick and tool-free conductor connection using direct plug-in technology.
- ▶ Replacing a damaged relay is quick and easy.



### SAFE

Push-in connections avoid downtime, reduce maintenance, and lower installation costs.

- ▶ No heat risk
- ▶ No risk of breaking the terminals on the product due to excessive tightening
- ▶ Retightening of screws is no longer necessary and operation in vibrating environments is no longer a problem.
- ▶ Touchproof protection without having to add cover.

## SOR

The SOR range of single-phase solid state relays with spring terminal connection is available in several versions dedicated to AC-1 resistive loads

- ▶ Current limiter
- ▶ Green control status LED
- ▶ Voltage protection on input (transil)
- ▶ Connection on the power side : 2 x doubled 6mm<sup>2</sup> or AWG10
- ▶ Connection on the control side : 2 x doubled 2.5mm<sup>2</sup> or AWG14

You can find more information on the standards applicable to our products by referring to our technical datasheets.



● Dim. 45 x 59 x 41.2 mm  
(1.77 x 2.32 x 1.62 in)

Product reference	Thyristor rating	Max. switching current at 40°C	Switching voltage	Peak voltage	Control voltage	I <sup>2</sup> t	Protec.
SOR943440-HE	35A	35A	12-280VAC	600V	3-32VDC	882A <sup>2</sup> s	TVS
SOR965440-HE	50A	41A	24-660VAC	1200V	3.5-32VDC	1680A <sup>2</sup> s	TVS
SOR967440	90A	41A	24-660VAC	1200V	3.5-32VDC	7200A <sup>2</sup> s	TVS

All these products must be mounted on heatsinks in order to reach nominal performance.

### ▶ "Ready to use" models with integrated heatsink

Product reference	Thyristor rating	Max. switching current at 40°C	Switching voltage	Peak voltage	Control voltage	I <sup>2</sup> t	Protec.
SOR943440-HE-WF151	35A	28A	12-280VAC	600V	3-32VDC	882A <sup>2</sup> s	TVS
SOR965440-HE-WF114	50A	34A	24-660VAC	1200V	3.5-32VDC	1680A <sup>2</sup> s	TVS

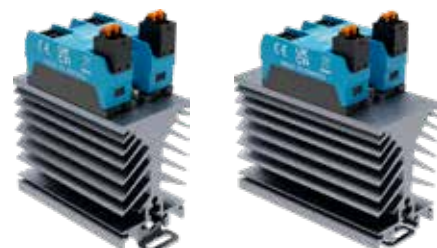



# Single phase Solid State Relays

## celpac<sup>®</sup> 2G

### The 22.5 mm (0.89 in) wide SSR solution!

#### Performances & reliability

- ▶ It has the same center-to-center fastening as the celduc SO and SC ranges,
- ▶ Maximum voltage up to 1600V (690VRMS), 600VAC and 1200VAC as standard,
- ▶ Thyristor rating up to 75A,
- ▶ Large input range : 3-32VDC with regulated current models,
- ▶ Models available with AC,
- ▶ Yellow input status LED,,
- ▶ Over-voltage protection on the input,
- ▶ New generation of TMS<sup>2</sup> technology for thyristors for a longer life expectancy,
- ▶ Quick and easy connections,
- ▶ Designed according to European standards EN60947-4-3 (IEC947- 4-3) and IEC/EN60335-1 - VDE0700-1 - IEC62314 - UL-cUL,
- ▶ IP20 protection with removable flaps (SU range) or cover (SA range),
- ▶ Other protection devices available as an option : RC snubber, VDR, self turn-on.

#### A cost-effective and compact solution

- ▶ With an installation width of only 22.5 mm (0.89 in), our celpac<sup>®</sup> solid state relays and contacts take up the least possible space,
- ▶ Reduced assembly time, simple wiring,
- ▶ Reduced maintenance thanks to a very long service life,
- ▶ A single screwdriver for both the output and input.

**REMINDER**

**SA7 / SU7** ▶ Random for inductive and motor loads

**SA8 / SU8** ▶ Zero-cross for all kinds of loads / heavy duty loads

**SA9 / SU9** ▶ Zero-cross for standard industrial loads / resistive loads AC-1 (AC-51)

"Ready to use" versions

**SAL / SUL** ▶ 22.5mm heatsink - 3K/W

**SAM / SUM** ▶ 45mm heatsink - 2.2K/W

### Multiple, simple and fast connections

	SA range	SU range
Connection on the power side ▶		Direct connection by wire or end fitting
Connection on the control side ▶		with screw connection on inputs
		with pluggable connector on inputs

#### Optional Modules

celduc<sup>®</sup> offers two optional modules that can be clipped directly onto the SU/SUL product range :

- ▶ **SAVE SPACE**
- ▶ **REDUCE COSTS**
- ▶ **INCREASE FUNCTIONALITY**

Diagnostic and current measurement module



ESUC (see page 27)

Temperature controller PID, current monitor and communication interface in one unit



ECOM (see page 27)

# Single phase Solid State Relays



**celpac**<sup>®</sup> 2G

**SA range**  
with screw connection on inputs



Our SA range has a screw-mounted connection on the power side and the control side. Our products include a transparent protective cover and some models are "ready to use" with built-in heatsinks (SAL and SAM versions).

## SA

For mounting on the heatsink of your choice

**SA8** : Zero-cross / designed for heavy duty loads / VDR protection included  
**SA9** : Zero-cross / designed for standard industrial loads / resistive loads AC-1

Product reference	Max. switching current	Switching voltage	Peak voltage	Control voltage	I <sup>2</sup> t	Protec.
SA842070	25A	12-275VAC	600V	3-32VDC	600A <sup>2</sup> s	VDR
SA942460	25A	12-280VAC	600V	3-32VDC	450A <sup>2</sup> s	-
SA963460	35A	24-600VAC	1200V	3.5-32VDC	882A <sup>2</sup> s	-
SA965460	50A	24-600VAC	1200V	3.5-32VDC	1 680A <sup>2</sup> s	-

All these products must be mounted on heatsinks in order to reach nominal performance



● Dim. 22.5 x 90 x 42 mm  
(0.87 x 3.54 x 1.65 in)

## SAL / SAM

"Ready to use" version

**SAx9** : Zero-cross / designed for standard industrial loads / resistive loads AC-1

Product reference	Thyristor rating	Max. switching current at 40°C	Switching voltage	Peak voltage	Control voltage	I <sup>2</sup> t	Regulated control current	Specifications
SAL942460	25A	20A	12-280VAC	600V	3-32VDC	450A <sup>2</sup> s	no	With simplified input
SAL961360	15A	12A	24-600VAC	1200V	6-32VDC	882A <sup>2</sup> s	yes	Control current < 10mA
SAL962360	25A	18A	24-600VAC	1200V	6-32VDC	882A <sup>2</sup> s	yes	Control current < 10mA
SAL963460	35A	21A	24-600VAC	1200V	3.5-32VDC	882A <sup>2</sup> s	no	With simplified input
SAL965460	50A	22A	24-600VAC	1200V	3.5-32VDC	1 680A <sup>2</sup> s	no	With simplified input
SAM943460	35A	28A	12-280VAC	600V	3-32VDC	882A <sup>2</sup> s	no	With simplified input
SAM963360	35A	28A	24-600VAC	1200V	6-32VDC	882A <sup>2</sup> s	yes	Control current < 10mA
SAM965360	50A	30A	24-600VAC	1200V	6-32VDC	1 680A <sup>2</sup> s	yes	Control current < 10mA



**SAL**  
● Dim. 22.5 x 90 x 112 mm  
(0.87 x 3.54 x 4.41 in)



**SAM**  
● Dim. 45 x 90 x 112 mm  
(1.77 x 3.54 x 4.41 in)





# Single phase Solid State Relays

Our entire SU range have pluggable connectors. Our products also include removable protective shutters and some models are "ready to use" with built-in heatsinks (SUL and SUM versions).

## SU range

with pluggable connector on inputs



## SU

For mounting on the heatsink of your choice

**SU7** : Random

**SU8** : Zero-cross / designed for heavy duty loads / VDR protection included

**SU9** : Zero-cross / designed for standard industrial loads / resistive loads AC-1



You can find more information on the standards applicable to our products by referring to our technical datasheets.

Product reference	Max. switching current	Switching voltage	Peak voltage	Control voltage	I <sup>2</sup> t	Protec.
SU765070	50A	24-510VAC	1200V	3.5-32VDC	1 680A <sup>2</sup> s	VDR
SU842070	25A	12-275VAC	600V	3-32VDC	600A <sup>2</sup> s	VDR
SU842770	25A	12-275VAC	600V	18-30VAC/DC	600A <sup>2</sup> s	VDR
SU842970	25A	12-275VAC	600V	160-240VAC	600A <sup>2</sup> s	VDR
SU865070	50A	24-510VAC	1200V	3.5-32VDC	1 680A <sup>2</sup> s	VDR
SU865770	50A	24-510VAC	1200V	18-30VAC/DC	1 680A <sup>2</sup> s	VDR
SU865970	50A	24-510VAC	1200V	160-240VAC	1 680A <sup>2</sup> s	VDR
SU867070	75A	24-510VAC	1200V	3.5-32VDC	7 200A <sup>2</sup> s	VDR
SU942460	25A	12-280VAC	600V	3-32VDC	600A <sup>2</sup> s	-
SU963460	35A	24-600VAC	1200V	3.5-32VDC	882A <sup>2</sup> s	-
SU965460	50A	24-600VAC	1200V	3.5-32VDC	1 680A <sup>2</sup> s	-
SU967460	75A	24-600VAC	1200V	3.5-32VDC	7 200A <sup>2</sup> s	-



● Dim. 22.5 x 90 x 42 mm (0.87 x 3.54 x 1.65 in)

All these products must be mounted on heatsinks in order to reach nominal performance.

## SUL / SUM

"Ready to use" version

**SUx7** : Random / designed for inductive and motor loads

**SUx8** : Zero-cross / designed for heavy duty loads / VDR protection included

**SUx9** : Zero-cross / designed for standard industrial loads / resistive loads AC-1

Product reference	Thyristor rating	Max. switching current at 40°C	Switching voltage	Peak voltage	Control voltage	I <sup>2</sup> t	Protec.
SUL765070	50A	22A	24-510VAC	1200V	3.5-32VDC	1 680A <sup>2</sup> s	VDR
SUL842070	25A	20A	12-275VAC	600V	3-32VDC	600A <sup>2</sup> s	VDR
SUL842770	25A	20A	12-275VAC	600V	18-30VAC/DC	600A <sup>2</sup> s	VDR
SUL842970	25A	20A	12-275VAC	600V	160-240VAC	600A <sup>2</sup> s	VDR
SUL865070	50A	22A	24-510VAC	1200V	3.5-32VDC	1 680A <sup>2</sup> s	VDR
SUL865770	50A	22A	24-510VAC	1200V	18-30VAC/DC	1 680A <sup>2</sup> s	VDR
SUL865970	50A	22A	24-510VAC	1200V	160-240VAC	1 680A <sup>2</sup> s	VDR
SUL867070	75A	24A	24-510VAC	1200V	3.5-32VDC	7 200A <sup>2</sup> s	VDR
SUL942440	25A	20A	12-280VAC	600V	3-32VDC	600A <sup>2</sup> s	TVS
SUL942460	25A	20A	12-280VAC	600V	3-32VDC	600A <sup>2</sup> s	-
SUL963440-HE	35A	26A	24-600VAC	1200V	3.5-32VDC	882A <sup>2</sup> s	TVS
SUL963460	35A	26A	24-600VAC	1200V	3.5-32VDC	882A <sup>2</sup> s	-
SUL963840-HE	35A	26A	24-600VAC	1200V	80-140VAC/DC	882A <sup>2</sup> s	TVS
SUL963940-HE	35A	26A	24-600VAC	1200V	180-280VAC/DC	882A <sup>2</sup> s	TVS
SUL965440-HE	50A	27A	24-600VAC	1200V	3.5-32VDC	1 680A <sup>2</sup> s	TVS
SUL965460	50A	27A	24-600VAC	1200V	3.5-32VDC	1 680A <sup>2</sup> s	-
SUL965840-HE	50A	26A	24-600VAC	1200V	80-140VAC/DC	1 680A <sup>2</sup> s	TVS
SUL965940-HE	50A	26A	24-600VAC	1200V	180-280VAC/DC	1 680A <sup>2</sup> s	TVS
SUL967440	75A	29A	24-600VAC	1200V	3.5-32VDC	7 200A <sup>2</sup> s	TVS
SUL967460	75A	29A	24-600VAC	1200V	3.5-32VDC	7 200A <sup>2</sup> s	-
SUL967840	75A	29A	24-600VAC	1200V	80-140VAC/DC	7 200A <sup>2</sup> s	TVS
SUL967940	75A	29A	24-600VAC	1200V	180-280VAC/DC	7 200A <sup>2</sup> s	TVS
SUM865070	50A	39A	24-510VAC	1200V	3.5-32VDC	1 680A <sup>2</sup> s	VDR
SUM867070	75A	39A	24-510VAC	1200V	3.5-32VDC	7 200A <sup>2</sup> s	VDR



SUL  
● Dim. 22.5 x 90 x 42 mm (0.87 x 3.54 x 4.41 in)



SUM  
● Dim. 45 x 90 x 112 mm (1.77 x 3.54 x 4.41 in)



**celpac**<sup>®</sup> 2G

## Optional modules

We offers two modules that are directly pluggable onto our SU/SUL/SUM type SSRs

- ▶ SAVE ROOM
- ▶ SAVE COSTS
- ▶ ADD MORE FUNCTIONALITY



## ESUC

### Current monitoring module

To combine with our SU/SUL/SUM in order to add monitoring functionality to our SSRs :

#### Diagnostics and control of up to 5 heater loads:

- ▶ Continuous current monitoring,
- ▶ Current set point training function via a push-button or external binary input,
- ▶ 2 alarm thresholds (+/-16%),
- ▶ Partial load break detection,
- ▶ Open load detection,
- ▶ SSR short circuit detection.

Product reference	Current range	Control
ESUC0450	2-40A	8-30VDC
ESUC0480	2-40A	16.8-45VDC
ESUC0150	1-10A	8-30VDC



#### Why choose this function?

- ▶ Quick fault detections (instantaneous alarm)
- ▶ Improves maintenance
- ▶ Helps detect heater faults and speeds up repairs.
- ▶ Maintains good quality production for plastic/rubber machines (specially thermosetting machines).
- ▶ 22.5mm wide with integrated heatsink and DIN rail adaptor
- ▶ Reduction of quantity, cost and time of wiring.

## ECOM0010

### Temperature controller PID, current monitor and communication interface in one unit

To combine with our SU/SUL/SUM in order to add monitoring functionality and a communication interface to our SSRs :

#### Temperature controller with :

- ▶ PID controller with automatic or manual tuning,
- ▶ Insulated inputs for J, K, T, E thermocouples, PT100 to come
- ▶ Auxiliary output for heating, cooling, alarm or to control a 3 phase Solid State Relay,
- ▶ Loop and heater fault alarms.

- Current monitoring up to 50A with current transformer
- RS485/Modbus RTU serial link (others available on request)
- Power supply : 24Vdc +/- 10%



#### Why choose this function?

- ▶ ECOM is the most compact solution available on the market, incorporating the latest measuring and control technology.
- ▶ By reducing wiring costs and minimizing the size of electrical cabinets, this solution increases efficiency.



# Solid State Relays **with diagnostics**

## Which solution to choose ?

celduc® relays offers different relay diagnosis solutions. These relays inform the user of the load status (resistive load), the output of the relay and the network.

Here are a few examples of our customers' requirements:

### Requirement

- ▶ 1 relay for 1 heating element + 1 sensing element
- ▶ 1 relay for 1 heating element + 1 rapid sensing element + compact and ready to use solution

### Solutions

- ▶ SOD
- ▶ SILD



### Advantages

- ▶ These relays let the user know the status of the load (connected or not), the relay output (closed or not) and the network (fuse or circuit breaker status) in the power circuit, via an NC (Normally Closed) diagnostic contact.
- ▶ A single input PLC that can be placed in a series
- ▶ Easy to use
- ▶ The diagnostic function does not require an external power supply
- ▶ Quick reaction time < 100 ms

### Requirement

- ▶ Reading the current and alarms via a communication interface

### Solutions

- ▶ Combined ECOM module with our SU / SUL solid state relays



### Advantages

- ▶ This product, which has been designed for temperature control (with built-in PID), can also be used to:
  - Measure the load current
  - Measure the ambient temperature, the process or even the relay or its heatsink (built-in J, K, T, E thermocouple input)
  - Create alarms (current, temperature, relay status)
  - Adjust the power on the load via a chrono-proportional control
- ▶ It communicates via an RS485 link and a MODBUS RTU protocol.
- ▶ In order to view the status locally, it has 3 LEDs and a configurable output.

### Requirement

- ▶ 1 relay for several loads + need for a compact and ready to use solution

### Solutions

- ▶ ESUC current detection module combined with our SU/SUL solid state relays



### Advantages

- ▶ Detection of partial load break or current surge (operates with up to 5 identical loads)
- ▶ Three-phase or possible multizone use
- ▶ Minimal dimensions: only 22.5 mm wide

### Requirement

- ▶ Connect/disconnect areas with heating :

This solution is ideal for thermoforming machines where the heating surface needs to be adapted to the size of the plastic sheets intended for preheating. Standard diagnostic solid state relays display an error when a heated area is disconnected. This requires a specific and sometimes complex management of the diagnostic signals.

### Solutions

- ▶ SOI



### Advantages

The main function of the SOI product range is to switch the load current. It also provides information about the presence (or lack thereof) of the output current which must then be interpreted by the user or the system.

# Solid State Relays with diagnostics



Our power SSRs with diagnostics are housed in celpac units, these include our SILD and okpac® ranges (to mount on heatsinks) and our SOD and SOI ranges. These relays let the user know the status of the load (resistive load), the relay output and the network via an NC (Normally Closed) diagnostic contact. The diagnostic function does not require an external power supply (celduc® patent). The contacts of different relays can also be placed in a series. It is possible to use these relays for diagnostics in a three-phase system, star connection wiring without neutral. Our SOI range includes a current transformer (CT) and a contact for signaling. This makes it possible to switch the load current by providing information about the presence (or lack thereof) of the output current which must then be interpreted by the user or the system.

## SEE ALSO

- Our current monitoring and communication interface : ESUC and ECOM optional modules (page 27)
- Our 2-legs, three-phase SSR with an auxiliary contact that can be used to detect various failures with the load (open circuit) or on the SSR (short-circuit) (page 34).

## SOD

You can find more information on the standards applicable to our products by referring to our technical datasheets.



Product reference	Max. switching current	Switching voltage	Peak voltage	Control voltage	I²t
SOD843180	35A	50-265VAC	600V	7-30VDC	1 250A²s
SOD845180	50A	50-265VAC	600V	7-30VDC	2 800A²s
SOD849180	125A	50-265VAC	600V	7-30VDC	22 000A²s
SOD865180	50A	150-510VAC	1200V	7-30VDC	2 800A²s
SOD867180	75A	150-510VAC	1200V	7-30VDC	7 200A²s

All these products must be mounted on heatsinks in order to reach nominal performance.



• Dim. 45 x 58.5 x 33.6 mm (1.77 x 2.28 x 1.30 in)

## SILD

You can find more information on the standards applicable to our products by referring to our technical datasheets.



The SILD power SSR with diagnostics range is housed in a celpac (ready to use) unit.

Product reference	Thyristor rating	Max switching current at 40°C	Switching voltage	Peak voltage	Control voltage	I²t
SILD845160	50A	28A	70-280VAC	600V	3-32VDC	1500A²s
SILD865170	50A	28A	150-510VAC	1200V	3.5-32VDC	1500A²s
SILD867170	75A	30A	150-510VAC	1200V	3.5-32VDC	5000A²s



• Dim. 22.5 x 80 x 116 mm (0.87 x 3.15 x 4.57 in)

## SOI

You can find more information on the standards applicable to our products by referring to our technical datasheets.



### Operation

By applying or removing a voltage on the control input, the SOI relay switches or disconnects the current in the load. If the value of the load current is greater than the factory setting threshold, the current transformer included in the SOI will close the contact for signaling. It therefore indicates that a current is flowing in the load, then the user or the system interprets this status.

### Advantages

- ▶ Reduction of quantity, cost and time of wiring
- ▶ Elimination of the need to pass the power cables through a current transformer
- ▶ Elimination of costly analog inputs on the PLC

Product reference	Thyristor rating	Switching voltage	Peak voltage	Control voltage	I²t
SOI885070	50A	24-625VAC	1600V	3.5-32VDC	2 800A²s

All these products must be mounted on heatsinks in order to reach nominal performance.



• Dim. 45 x 58.5 x 33.6 mm (1.77 x 2.28 x 1.30 in)



# Two-phase Solid State Relays

Our two-phase product range provides two solid state relays in a compact standard 45 mm (1.77 in) enclosure. They are perfectly adapted to three phase applications with breaking of two phases only.

## Wiring examples

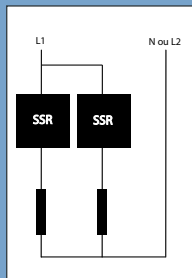

Control of 2 single-phase wired heating elements.

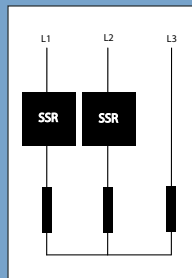

Two-phase SOB SSR to control heating elements wired in a star connection. Specifically designed for balanced low voltage loads without neutral.

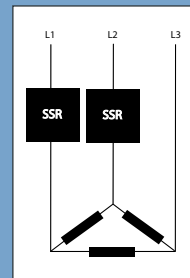

Two-phase SOB SSR to control heating elements wired in a delta connection. Specifically designed for high voltage loads, balanced or not.



## SIB Zero-cross

You can find more information on the standards applicable to our products by referring to our technical datasheets.



Two-phase Solid State Relay in a compact 22.5mm (0.89 in) housing

Product reference	Max. switching current	Switching voltage	Peak voltage	Control voltage	I <sup>2</sup> t	Specifications
SIB942360	2x30A	12-280VAC	600V	12-24VDC	487A <sup>2</sup> s	1 common input



● Dim. 22.5 x 80 x 42.6 mm (0.89 x 3.15 x 1.68 in)

All these products must be mounted on heatsinks in order to reach nominal performance.

## SOB5 Zero-cross

You can find more information on the standards applicable to our products by referring to our technical datasheets.



- ▶ Power and control connections by FASTON terminals (Fig.1)
- ▶ Double input with connector CE100F ITW PANCON type or similar + Power connection by FASTON 6.3mm terminals with IP20 protection (Fig.2)

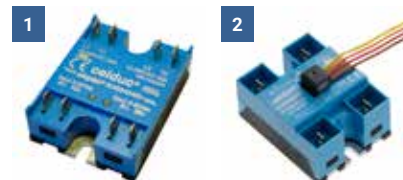

● Dim. 45 x 58.5 x 27 mm (1.77 x 2.28 x 1.06 in)

Product reference	Thyristor rating	Max. switching current at 40°C	Switching voltage	Peak voltage	Control voltage	I <sup>2</sup> t	Specifications	Fig n°
SOB542460	2x25A	2x25A	12-280VAC	600V	3-32VDC	265A <sup>2</sup> s	2 controls	1
SOB562460	2x25A	2x25A	24-600VAC	1200V	3.5-32VDC	265A <sup>2</sup> s	2 controls	1
SOB544330	2x40A	2x25A	12-275VAC	600V	8-30VDC	882A <sup>2</sup> s	2 controls	2
SOB564330	2x40A	2x25A	24-600VAC	1200V	10-30VDC	882A <sup>2</sup> s	2 controls	2

All these products must be mounted on heatsinks in order to reach nominal performance.

## SOB6 Zero-cross

You can find more information on the standards applicable to our products by referring to our technical datasheets.



Our SOB6 two-phase Solid State Relays have a double input with connector CE100F ITW PANCON type or similar.

Product reference	Max. switching current	Switching voltage	Peak voltage	Control voltage	I <sup>2</sup> t	Specifications
SOB665300	2x50A	24-600VAC	1200V	10-30VDC	1680A <sup>2</sup> s	2 controls



● Dim. 45 x 58.5 x 27 mm (1.77 x 2.28 x 1.06 in) (Connectors not included)

All these products must be mounted on heatsinks in order to reach nominal performance.



# Two-phase Solid State Relays



## SOB7

You can find more information on the standards applicable to our products by referring to our technical datasheets.



The SOB7 range with instant switching.

Product reference	Thyristor rating	Max. switching current at 40°C	Switching voltage	Peak voltage	Control voltage	I <sup>2</sup> t	Specifications
SOB763670	2x35A	2x35A	24-510VAC	1200V	8-30VDC	1250A <sup>2</sup> s	2 controls
SOB765670	2x50A	2x50A	24-510VAC	1200V	8-30VDC	2500A <sup>2</sup> s	2 controls
SOB767670	2x75A	2x50A	24-510VAC	1200V	8-30VDC	7200A <sup>2</sup> s	2 controls



All these products must be mounted on heatsinks in order to reach nominal performance.

● Dim. 45 x 58.5 x 27 mm (1.77 x 2.28 x 1.06 in)  
(Connectors to be ordered separately. - see page 47)

## SOB8

You can find more information on the standards applicable to our products by referring to our technical datasheets.



The SOB8 range with zero-cross switching is designed for most types of loads.

Product reference	Thyristor rating	Max. switching current at 40°C	Switching voltage	Peak voltage	Control voltage	I <sup>2</sup> t	Specifications
SOB863860	2x35A	2x35A	24-600VAC	1200V	17-30VAC/DC	882A <sup>2</sup> s	2 controls
SOB865660	2x50A	2x50A	24-600VAC	1200V	8-30VDC	2500A <sup>2</sup> s	2 controls
SOB867640	2x75A	2x50A	24-510VAC	1200V	8-30VDC	7200A <sup>2</sup> s	2 controls / TVS



All these products must be mounted on heatsinks in order to reach nominal performance.

● Dim. 45 x 58.5 x 27 mm (1.77 x 2.28 x 1.06 in)  
(Connectors not included)

## SOB9

You can find more information on the standards applicable to our products by referring to our technical datasheets.



The zero cross SOB9 range is specifically designed for AC-1 resistive loads.

Product reference	Thyristor rating	Max. switching current at 40°C	Switching voltage	Peak voltage	Control voltage	I <sup>2</sup> t	Specifications
SOB942360	2x25A	2x25A	12-280VAC	600V	10-30VDC	600A <sup>2</sup> s	1 control
SOB942660	2x25A	2x25A	12-280VAC	600V	10-30VDC	600A <sup>2</sup> s	2 controls
SOB943360	2x35A	2x35A	12-280VAC	600V	10-30VDC	1 250A <sup>2</sup> s	1 control
SOB945360	2x50A	2x50A	12-280VAC	600V	10-30VDC	2 800A <sup>2</sup> s	1 control
SOB962060	2x25A	2x25A	24-600VAC	600V	3.5-32VDC	380A <sup>2</sup> s	2 controls
SOB963660	2x35A	2x35A	24-600VAC	1200V	10-30VDC	1250A <sup>2</sup> s	2 controls
SOB965060	2x50A	2x50A	24-600VAC	1200V	3.5-32VDC	1 680A <sup>2</sup> s	2 controls
SOB965160	2x50A	2x50A	24-600VAC	1200V	6-16VDC	1 680A <sup>2</sup> s	2 controls
SOB965160-TH	2x50A	2x50A	24-600VAC	1200V	6-16VDC	1 680A <sup>2</sup> s	2 control / Thermal pad mounted
SOB965360	2x50A	2x50A	24-600VAC	1200V	10-30VDC	2800A <sup>2</sup> s	1 control
SOB965660	2x50A	2x50A	24-600VAC	1200V	10-30VDC	2800A <sup>2</sup> s	2 controls
SOB965660-TH	2x50A	2x50A	24-600VAC	1200V	10-30VDC	2800A <sup>2</sup> s	2 control / Thermal pad mounted
SOB965670-TH	2x50A	2x50A	24-510VAC	1200V	10-30VDC	2800A <sup>2</sup> s	2 control / VDR / Thermal pad mounted
SOB967660	2x75A	2x50A	24-600VAC	1200V	10-30VDC	7200A <sup>2</sup> s	2 controls



● Dim. 45 x 58.5 x 27 mm (1.77 x 2.28 x 1.06 in)  
(Connectors not included)

All these products must be mounted on heatsinks in order to reach nominal performance.

Product reference	Thyristor rating	Max. switching current at 40°C	Switching voltage	Peak voltage	Control voltage	I <sup>2</sup> t	Specifications
SOB96366WF	2x35A	2x15A	24-600VAC	1200V	10-30VDC	1250A <sup>2</sup> s	2 controls / mounted on heatsink





# Two-phase Solid State Relays



**NEW**

## Two-phase Solid State Relays with push-in spring terminals

Fast wiring, even in tight spaces !

Easy to use and requiring no special tools, this connection technology is perfect for compact installations where you need fast and safe wiring.



### STRONG

Push-in connections are strong and reliable.



### FLEXIBLE

Push-in connections are suitable for various types of conductors : solid conductors, stranded conductors, and for fine-stranded conductors with crimped-on ferrules.



### FAST

- ▶ Quick and tool-free conductor connection using direct plug-in technology.
- ▶ Replacing a damaged relay is quick and easy.



### SAFE

Push-in connections avoid downtime, reduce maintenance, and lower installation costs.

- ▶ No heat risk
- ▶ No risk of breaking the terminals on the product due to excessive tightening
- ▶ Retightening of screws is no longer necessary and operation in vibrating environments is no longer a problem.
- ▶ Touchproof protection without having to add cover.

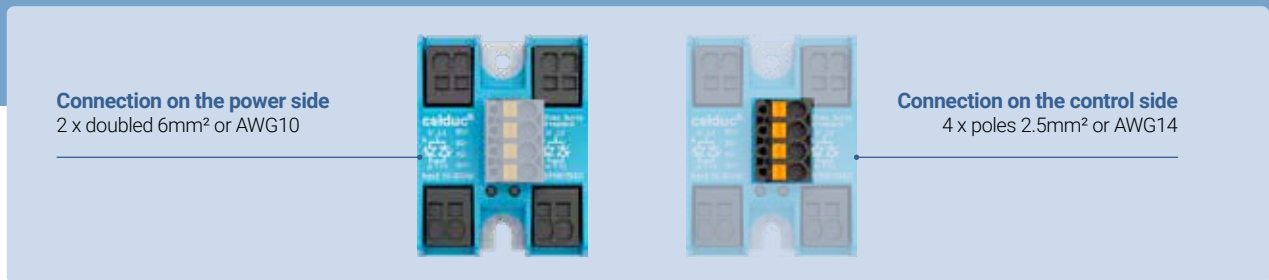

## SOBR

You can find more information on the standards applicable to our products by referring to our technical datasheets.



The new SOBR range of two-phase solid state relays has expanded and now offers new models with push-in spring terminals. This product range is designed to be used with AC-1 resistive loads.

- ▶ 2 x Green input status LEDs
- ▶ Connection on the power side : Double "push-in" type spring terminals (Max 6mm<sup>2</sup> or 10 AWG)
- ▶ Connection on the control side : Pluggable "push-in" type spring terminals (Max 2.5mm<sup>2</sup> or 14 AWG)

Product reference	Thyristor rating	Max. switching current at 40°C	Switching voltage	Peak voltage	Control voltage	I <sup>2</sup> t	Protec.
SOBR943640-HE	2x35A	2x35A	12-280VAC	600V	10-30VDC	882A <sup>2</sup> s	TVS
SOBR965640-HE	2x50A	2x41A	24-600VAC	1200V	10-30VDC	1680A <sup>2</sup> s	TVS
SOBR967640	2x75A	2x41A	24-600VAC	1200V	10-30VDC	7200A <sup>2</sup> s	TVS



● Dim. 45 x 59 x 48.1 mm (1.77 x 2.32 x 1.89 in)

All these products must be mounted on heatsinks in order to reach nominal performance

- ▶ "Ready to use" model with integrated heatsink.

Product reference	Thyristor rating	Max. switching current at 40°C	Switching voltage	Peak voltage	Control voltage	I <sup>2</sup> t	Protec.
SOBR965640-HE-WFF05	2x50A	2x41A	24-600VDC	1200V	10-30VDC	1680A <sup>2</sup> s	TVS









# Three-phase Solid State Relays



celduc® relays has several ranges of solid-state relays for three-phase applications. Various models are available with ratings up to 125A max. per phase, with either AC or DC input and with instant or zero cross switching.

## Wiring examples

	cel3pac®	sightpac®
	<ul style="list-style-type: none"> <li>• Version with 100 mm (3.94 in) installation width,</li> <li>• Small footprint: 34.7 mm height,</li> <li>• Improved connections to increase switching current limits,</li> <li>• Increase in the size of terminals on the power side: up to 50 mm<sup>2</sup></li> </ul>	<ul style="list-style-type: none"> <li>• Compact 45 mm (1.77 in) version,</li> <li>• Same fixing distance as our okpac® and celpac® ranges,</li> <li>• An innovative and scalable range (optional future modules).</li> </ul>
<b>Power wiring</b>	<p>Standard with screws</p>  <p>With spring connectors</p> 	<p>Standard with screws</p>  <p>With spring connectors</p> 
<b>Control wiring</b>	<p>Standard with screws or 4-pole pluggable spring connector (others available on request)</p>  	<p>With pluggable connector</p> 

## Easy and fast connections

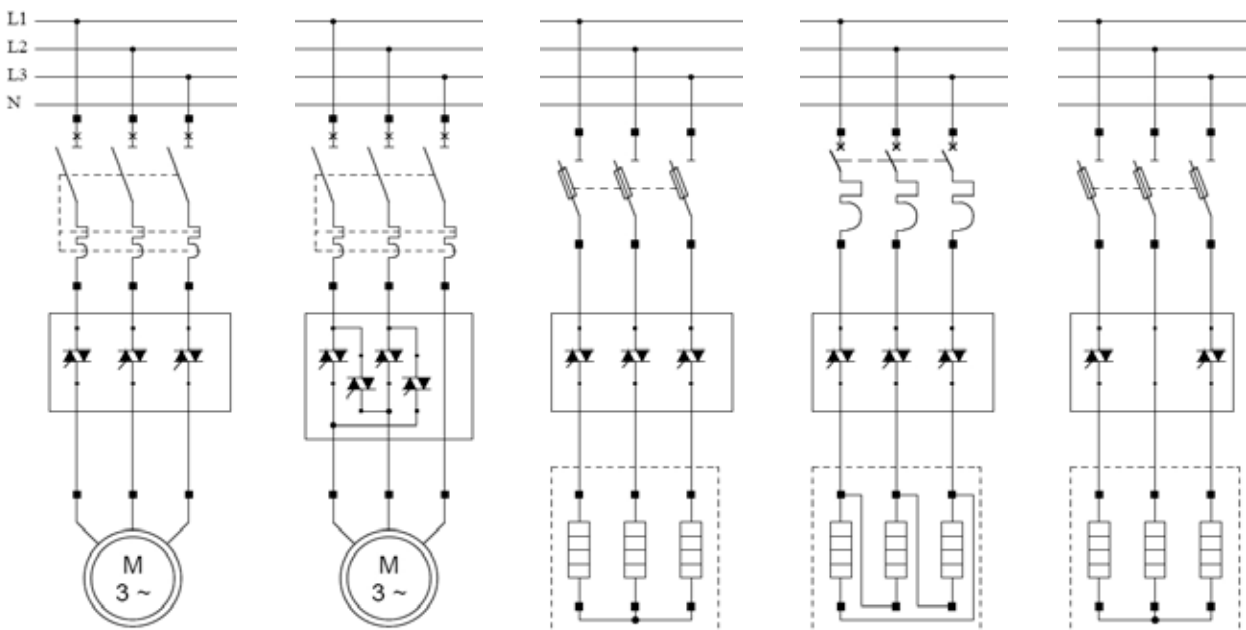

A three-phase SMT8/SGT8 type SSR controlling an AC-53 three-phase motor with thermal magnetic protection.

An SMR/SGR/SV9 inverter type three-phase SSR reversing the rotation direction of a three-phase asynchronous motor.

An SMT/SGT type three-phase SSR to control heating elements wired in a star connection with fuse protection.

An SMT/SGT type three-phase SSR to control heating elements wired in a delta connection with modular circuit breaker protection.

An SMB/SGB type SSR to control heating elements wired in a star connection with fuse protection.



# Three-phase Solid State Relays

## sightpac®

### 45 mm (1.77 in) wide version!

REMINDER

SMB8 / SMT8 / SGB8

► Zero Cross For Heavy Duty Loads.

## SMB

### 2 leg three-phase SSRs

You can find more information on the standards applicable to our products by referring to our technical datasheets.



This range has been designed to control three-phase loads with a delta connection, if balanced, with a star connection without neutral. Two of the three phases are switched, the third is directly connected.

Product reference	Thyristor rating	Max. switching current AC-1 at 40°C	Max. switching current AC-3 at 40°C	Switching voltage	Peak voltage	Control voltage	I²t	Protections
SMB8650510	3x50A	3x50A	3x12A	24-520VAC	1600V	4-30VDC	2 800A²s	RC - VDR
SMB8670910	3x75A	3x75A	3x16A	150-520VAC	1600V	4-30VDC	7 200A²s	RC - VDR + auxiliary contact
SMB8850210	3x50A	3x50A	3x12A	24-640VAC	1600V	4-30VDC	2 800A²s	RC - VDR

All these products must be mounted on heatsinks in order to reach nominal performance.

**An auxiliary contact allows the detection of various conditions:** relay short-circuited or open load. The status (static) output is normally closed in the absence of faults on the load or on the relay itself. In the event of a fault, the status output is open. Several status outputs (NC) can be put in series to have a single fault information. Typical applications: Three-phase applications where the problem must be detected immediately due to the relay being used in a high-speed process.



● Dim. 45 x 100 x 48 mm (1.77 x 3.94 x 1.89 in)

## SMT

### Three-phase SSRs with pluggable connectors

You can find more information on the standards applicable to our products by referring to our technical datasheets.



Product reference	Thyristor rating	Max. switching current AC-1 at 40°C	Max. switching current AC-3 at 40°C	Switching voltage	Peak voltage	Control voltage	I²t	Protections
SMT8620520	3x25A	3x20A	3x5A	24-520VAC	1200V	4-30VDC	380A²s	RC - VDR
SMT8628520	3x25A	3x20A	3x5A	24-520VAC	1200V	24-255VAC/DC	380A²s	RC - VDR

All these products must be mounted on heatsinks in order to reach nominal performance.

● Dim. 45 x 100 x 48 mm (1.77 x 3.94 x 1.89 in)

► "Ready to use" version with built-in heatsink.

SMT8628521	3x25A	3x17A	3x5A	24-520VAC	1200V	24-255VAC/DC	380A²s	RC - VDR
------------	-------	-------	------	-----------	-------	--------------	--------	----------



## SGB

### 2 leg three-phase SSRs

You can find more information on the standards applicable to our products by referring to our technical datasheets.



Product reference	Thyristor rating	Max. switching current AC-1 at 40°C	Max. switching current AC-3 at 40°C	Switching voltage	Peak voltage	Control voltage	I²t	Protections
SGB8850200	3x50A	3x50A	3x12A	24-640VAC	1600V	4-30VDC	2 800A²s	VDR
SGB8890200	3x125A	3x125A	3x32A	24-640VAC	1600V	4-30VDC	22 000A²s	VDR

● Dim. 100 x 76.5 x 35.5 mm (3.94 x 2.99 x 1.38 in)



# Three-phase Solid State Relays



## cel3pac®

### Performance and reliability

#### REMINDER

- SGT7 ▶ Random or instant switching.
- SGT8 ▶ Zero cross for heavy duty loads.
- SGT9 ▶ Zero cross for AC-1 (AC-51) resistive loads.

## SGT

### With screw connections

You can find more information on the standards applicable to our products by referring to our technical datasheets.



1

• Dim. 100 x 76.5 x 35.5 mm (3.94 x 2.99 x 1.38 in)

Product reference	Thyristor rating	Max. switching current AC-1 at 40°C	Max. switching current AC-3 at 40°C	Switching voltage	Peak voltage	Control voltage	I <sup>2</sup> t	Protections	Fig n°
SGT7650500	3x50A	3x50A	3x12A	24-520VAC	1600V	4-30VDC	2 800A <sup>2</sup> s	RC - VDR	1
SGT7690500	3X125A	3X125A	3X32A	24-520VAC	1600V	4-30VDC	22 000A <sup>2</sup> s	RC - VDR	1
SGT8638500	3x35A	3x35A	3x7A	24-520VAC	1600V	24-255VAC/DC	1 250A <sup>2</sup> s	RC - VDR	1
SGT8658500	3x50A	3x50A	3x12A	24-520VAC	1600V	24-255VAC/DC	2 800A <sup>2</sup> s	RC - VDR	1
SGT8670500	3X75A	3X50A	3X16A	24-520VAC	1600V	4-30VDC	7 200A <sup>2</sup> s	RC - VDR	1
SGT8678500	3X75A	3X75A	3X16A	24-520VAC	1600V	24-255VAC/DC	7 200A <sup>2</sup> s	RC - VDR	1
SGT8690500	3X125A	3X75A	3X32A	24-520VAC	1600V	4-30VDC	22 000A <sup>2</sup> s	RC - VDR	1
SGT8698500	3X125A	3X125A	3X32A	24-520VAC	1600V	24-255VAC/DC	22 000A <sup>2</sup> s	RC - VDR	1
SGT8850200	3x50A	3X125A	3x12A	24-640VAC	1600V	4-30VDC	2 800A <sup>2</sup> s	VDR	1
SGT8858200	3x50A	3x50A	3x12A	24-640VAC	1600V	24-255VAC/DC	2 800A <sup>2</sup> s	VDR	1
SGT8859200	3x50A	3x50A	3x12A	24-640VAC	1600V	90-280VAC/DC	2 800A <sup>2</sup> s	VDR	1
SGT8879200	3x75A	3x50A	3X16A	24-640VAC	1600V	90-280VAC/DC	7 200A <sup>2</sup> s	VDR	1
SGT9424300	3x25A	3x25A	-	24-280VAC	600V	4-30VDC	882A <sup>2</sup> s	TVS	1
SGT9444300	3x50A	3x50A	-	24-280VAC	600V	4-30VDC	1680A <sup>2</sup> s	TVS	1
SGT9454300	3x50A	3x50A	-	24-280VAC	600V	4-30VDC	2 800A <sup>2</sup> s	TVS	1
SGT9474300	3x75A	3x75A	-	24-280VAC	600V	4-30VDC	7 200A <sup>2</sup> s	TVS	1
SGT9624300	3x25A	3x25A	-	24-600VAC	1200V	4-30VDC	882A <sup>2</sup> s	TVS	1
SGT9694300	3x125A	3x125A	-	24-600VAC	1200V	4-30VDC	22 000A <sup>2</sup> s	TVS	1
SGT9834300	3X35A	3X35A	-	24-640VAC	1600V	4-30VDC	1 250A <sup>2</sup> s	TVS	1
SGT9854300	3x50A	3x50A	-	24-640VAC	1600V	4-30VDC	2 800A <sup>2</sup> s	TVS	1
SGT9874300	3X75A	3X75A	-	24-640VAC	1600V	4-30VDC	7 200A <sup>2</sup> s	TVS	1

All these products must be mounted on heatsinks in order to reach nominal performance.

#### ► Version with built-in temperature alarm

SGT8650810	3x50A	3X42A	3x12A	24-520VAC	1600V	4-30VDC	2 800A <sup>2</sup> s	RC - VDR - Temperature alarm	2
------------	-------	-------	-------	-----------	-------	---------	-----------------------	------------------------------	---

The temperature Alarm detects over temperature of the device and resets below 70°C. If the preset temperature limit is exceeded, the temperature switch opens and the solid state relay is switched off. Typical application : 3 phase heating

#### ► "Ready to use" versions with built-in heatsink

SGT8658502	3x50A	3x24A	3x12A	24-520VAC	1600V	24-255VAC/DC	2 800A <sup>2</sup> s	RC - VDR	3
SGT8698503	3x125A	3x48A	3x32A	24-520VAC	1600V	24-255VAC/DC	22 000A <sup>2</sup> s	RC - VDR	4
SGT8698504	3x125A	3x64A	3x32A	24-520VAC	1600V	24-255VAC/DC	22 000A <sup>2</sup> s	RC - VDR	5
SGT9654302	3x50A	3x24A	-	24-600VAC	1200V	4-30VDC	1 680A <sup>2</sup> s	TVS	3

Other product options available on request.

2



• Dim. 100 x 76.5 x 35.5 mm (3.94 x 2.99 x 1.38 in)

3



• Dim. 98 x 89.8 x 104.7mm (3.86 x 3.54 x 4.12 in)

4



• Dim. 110 x 110 x 150.2mm (4.33 x 4.33 x 5.91 in)

5



• Dim. 145 x 110 x 149.7mm (5.71 x 4.33 x 5.89 in)



# Three-phase and Four-Leg Solid State Relays

## SGTR **NEW**

You can find more information on the standards applicable to our products by referring to our technical datasheets.



With push-in spring terminals

Product reference	Thyristor rating	Max. switching current AC-1 at 40°C	Max. switching current AC-3 at 40°C	Switching voltage	Peak voltage	Control voltage	I <sup>2</sup> t	Protections	Fig.
SGTR9854310	3x50A	3X41A	-	24-660VAC	1600V	4-30VDC	2 800A <sup>2</sup> s	TVS	1
SGTR8690510	3X125A	3X41A	3X32A	24-520VAC	1600V	4-30VDC	22 000A <sup>2</sup> s	VDR+RC	1
SGTR9854310-WF031	3x50A	3x41A	-	24-660VAC	1600V	4-30VDC	2 800A <sup>2</sup> s	TVS	2
SGTR9874310-WF108	3x75A	3x22A	-	24-660VAC	1600V	4-30VDC	7 200A <sup>2</sup> s	TVS	3

1  
● Dim. 100 x 77 x 47.5 mm  
(3.94 x 3.03 x 1.87 in)



"Ready to use" version with integrated heatsink



## Four-Leg Solid State Relays

Four-Leg SSRs offer four independently controlled AC output Solid State Relays in a single industry standard package. Our SMQR and SCQ models, offer customers a choice between push-in spring terminals or Faston terminals.

## SMQR

You can find more information on the standards applicable to our products by referring to our technical datasheets.



With push-in spring terminals

Product reference	Thyristor rating	Max. switching current AC-1 at 40°C	Switching voltage	Peak voltage	Control voltage	I <sup>2</sup> t	LED	Protections	Fig.
SMQR9623410	4x25A	4x25A	24-600VAC	1200V	10-30VDC	380A <sup>2</sup> s	oui	TVS	1
SMQR9623410-WFF05	4x25A	4x18A	24-600VAC	1200V	10-30VDC	380A <sup>2</sup> s	oui	TVS	2

All these products must be mounted on heatsinks in order to reach nominal performance.



1  
● Dim. 45 x 100 x 48.1mm  
(1.77 x 3.94 x 1.89 in)

"Ready to use" version with integrated heatsink



Other models on request.

## SCQ

You can find more information on the standards applicable to our products by referring to our technical datasheets.



With Faston terminals

Product reference	Max. switching current	Switching voltage	Peak voltage	Control voltage	I <sup>2</sup> t	Led	Specifications
SCQ842060	4x25A	12-280VAC	600V	3-32VDC	288A <sup>2</sup> s	yes	Common +VDC
SCQ842160	4x25A	12-280VAC	600V	3-32VDC	288A <sup>2</sup> s	yes	Common 0VDC + polarized connector

● Dim. 44.5 x 58.2 x 27 mm  
(1.73 x 2.28 x 1.06 in)





## SMR AC inverter

This range, equipped with pluggable connectors, is used to reverse the rotation direction of a motor (2.2 kW max.).

You can find more information on the standards applicable to our products by referring to our technical datasheets.



Product reference	Switching current AC-3 at 40°C	Switching voltage	Control voltage	I <sup>2</sup> t	Protec.	Specifications
SMR8621520	3x5A	24-520VAC	12-30VDC	380A <sup>2</sup> s	RC - VDR Reversing + Time delay	2 phase switching

All these products must be mounted on heatsinks in order to reach nominal performance.

● Dim. 45 x 100 x 48 mm  
(1.77 x 3.94 x 1.89 in)



## SGR AC inverter

This range is used to reverse the rotation direction of a motor (7.5kW max @400Vac)

You can find more information on the standards applicable to our products by referring to our technical datasheets.



Product reference	Switching current AC-3 at 40°C	Switching voltage	Control voltage	I <sup>2</sup> t	Protec.	Specifications
SGR8671510	3x16A	24-520VAC	12-30VDC	7200A <sup>2</sup> s	RC - VDR Reversing + Time delay	2 phase switching

All these products must be mounted on heatsinks in order to reach nominal performance.

● Dim. 100 x 76.5 x 35.5 mm  
(3.94 x 2.99 x 1.38 in)



## SG9 / SV9 / SW9 AC inverters

These relays are used to reverse the rotation direction of a motor.

The SV9 range is housed in an IP20 enclosure.

The SW9 range is ready to use with a heatsink and DIN rail mounting included.

They are all supplied with LED indicators and are protected from being gang-operated (interlocking).

Available with a 40 or 47.6 mm fixing distance ("E" suffix).

You can find more information on the standards applicable to our products by referring to our technical datasheets.



Product reference	Switching current AC-3 at 40°C	Switching voltage	Control voltage	I <sup>2</sup> t	Protec.	Specifications	Fig n°
SG969100	3 x 6,6A	24-500VAC	10-30VDC	612A <sup>2</sup> s		3 phase switching	1
SG969300E	3 x 8,5A	24-500VAC	12-30VDC	1500A <sup>2</sup> s	Reversing	2 phase switching	1
SV969300E	3 x 8,5A	24-500VAC	12-30VDC	1500A <sup>2</sup> s	+ Time delay	2 phase switching	2
SV969500E	3 x 16A	24-550VAC	12-30VDC	5000A <sup>2</sup> s	+ RC + VDR	2 phase switching	2
SW960330	3 x 4,5A	24-500VAC	12-30VDC	1500A <sup>2</sup> s		2 phase switching	3
SW961230	3 x 8,5A	24-500VAC	12-30VDC	1500A <sup>2</sup> s		2 phase switching	4



1  
● Dim. 100 x 73.5 x 39.5 mm  
(3.94 x 2.87 x 1.54 in)



2  
● Dim. 100 x 76 x 56.5 mm  
(3.94 x 2.99 x 2.20 in)



3  
● Dim. 100 x 76 x 72 mm  
(3.94 x 2.99 x 2.83 in)



4  
● Dim. 83 x 90 x 1555 mm  
(3.27 x 3.54 x 61.22 in)



# Motor control

## SGRD / XKRD DC inverters

The SGRD inverter includes all the control electronics as well as short circuit protection and lockout to prevent the two rotation directions from being gang-operated. Ready to use and mounted on a DIN rail, the XKRD30506 module consists of four static switches pre-wired in the inverter's rotation direction for a DC motor (100W @ 24VDC).

You can find more information on the standards applicable to our products by referring to our technical datasheets.



Product reference	Switching current	Switching voltage	Peak voltage	Control	Protec.	Fig. n°
SGRD01006	10A	8-36VDC	60V	contact/switch	Voltage and current	1
XKRD30506	5A	7-36VDC	60V	7-30VDC	-	2



1

• Dim. 100 x 73.5 x 50.9 mm (3.94 x 2.87 x 1.97 in)



2

• Dim. 58.2 x 76.4 x 53 mm (2.28 x 2.99 x 2.09 in)

## SMCV / SMCW

### Three-phase AC softstarters

#### Motor control:

- ▶ Effective reduction of torque and starting current.

#### Starting incandescent or infrared lamps:

- ▶ Inrush current reduction
- ▶ Increase in service life

#### Transformer control (loaded) :

- ▶ Saturation current removed
- ▶ Improved control and protection

#### Whatever your application :

- ▶ Network, load and product status diagnostics
- ▶ Better balance of and less interference on starters (full control of the 3 phases!)
- ▶ Easy to use and adjust
- ▶ As compact as an electromechanical contactor

You can find more information on the standards applicable to our products by referring to our technical datasheets.

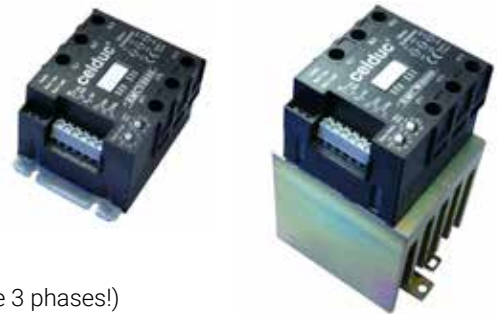

Product reference	Pmax motor 400VAC		Pmax motor 230VAC		Max. current. AC3a at 40°C		Specifications	Dimensions (in)
	Y*	D*	Y*	D*	Max.	EN60947-4-2		
SMCV6080	7.5kW	13kW	4.3kW	7.5kW	16A	11.5A	Heatsink not provided	3.94 x 2.99 x 2.28
SMCV6110	11kW	19kW	6.4kW	11kW	22A	15.5A	Heatsink not provided	3.94 x 2.99 x 2.28
SMCV6150	15kW	26kW	8.6kW	15kW	30A	22.5A	Heatsink not provided	3.94 x 2.99 x 2.28
SMCW6020	2.2kW	3.8kW	1.3kW	2.2kW	5A	3.5A	Built-in Din-Rail	3.27 x 4.33 x 2.91
SMCW6080	7.5kW	13kW	4.3kW	7.5kW	16A	11.5A	Built-in heatsink	3.27 x 4.33 x 6.10
SMCW6110	11kW	19kW	6.4kW	11kW	22A	15.5A	Built-in heatsink	4.33 x 4.33 x 7.09
SMCW6150	15kW	26kW	8.6kW	15kW	30A	22.5A	Built-in heatsink	4.33 x 5.55 x 7.09
SMCW6151	15kW	26kW	8.6kW	15kW	30A (AC3b)	22.5A (AC3b)	Built-in Din-Rail Ext. Bypass required	3.27 x 4.33 x 2.91

Common characteristics	Voltage range and network frequency	Control	Diagnostic output	Operating temperature	Insulation
Values given at 40°C ambient	200-480VAC 40-65Hz	10-24VDC ou contact	0-24V 1A AC/DC	-40°C +100°C	4kV

\*The star assembly (Y) corresponds to an on-line wired starter. The delta assembly (D) corresponds to the starter wired in the motor's delta connection. Each channel is wired in series with motor winding.





## Single phase and three-phase controllers

celduc® relays offers a wide range of controllers with various control modes and input types.

### Types of input control:

- ▶ 0-10VDC, 4-20mA , potentiometer or PWM (Pulse Width Modulation).

### 3 control modes are available:

- ▶ Burst control mode controllers
- ▶ Full wave pulse controllers
- ▶ Phase angle controllers

A technology for every application!

## Which mode to choose ?

Comparison of the 3 control modes (with load set at 50% of maximum value)

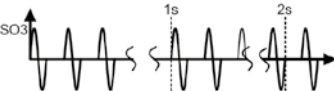
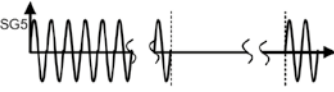
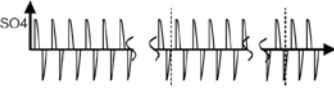
	Working principles	Advantages	Typical applications
<b>Burst control mode</b> <b>SO3 range</b> (page 41) 	In a given cycle time (in this case, 1 or 2 seconds), the variation of the load power is achieved by eliminating whole alternations. Eliminations are distributed in accordance with a complex rule. Thus, in this example, the load is only powered to 50% because of the elimination of one alternation out of two.	This type of control makes it possible for the power to be finely modulated in accordance with the analog control, while limiting disturbances.	For controlling resistive loads at low thermal inertia, such as short wave infrared emitters (infrared heater bulbs)
<b>Full wave pulse controllers</b> <b>SG5 range</b> (page 42) 	In a given cycle time (variable depending on the models), the variation of the load power is achieved by eliminating whole alternations. The elimination is performed linearly in accordance with the Ton/Tcycle duty cycle requested by the control input. Thus, in this example, the load is only powered for 50% of the cycle time (Ton/Tcycle=0.5).	This type of control has the advantage of not generating interference since trigger takes place at around 0 voltage.	Suitable for high inertia loads (industrial furnaces, etc.).
<b>Phase angle controllers</b> <b>Single phase</b> <b>SG4 - SO4 - SIL4 - SIM4 ranges</b> (pages 40 and 41) <b>Three-phase</b> <b>SGTA - SVTA ranges</b> (page 43) 	In terms of the principle of the light dimmer, this control mode makes it possible to finely vary the load power by removing a part of the supply voltage sinusoid in accordance with the control input. The proportional response between the control input and the power output depends on the controller model and can be linear in angle, $U^2$ or in Urms. Thus, in this example, the load is only powered to 50% because of the elimination of half of the supply voltage's half cycles.	This control mode makes it possible to finely adjust the load power, for example, when the accuracy of the temperature regulation is prioritized over the electromagnetic disturbances generated by this type of solution (a filter is recommended)	Mainly for loads that rapidly react when faced with voltage variations (lamps, motors, etc.). Also for DC loads behind a rectifier bridge (heater wires, Peltier effect modules, etc.).



# Single phase analog controllers

## SG4

You can find more information on the standards applicable to our products by referring to our technical datasheets.



### Single phase angle controllers with a built-in power supply

- ▶ Typical applications : light dimmers, heating regulation, single phase variable speed control (vibrating feeders,etc), temperature regulation
- ▶ Model with LED and RC network and VDR protection
- ▶ Built-in power supply : No external power supply required

Product reference	Max. switching current	Switching voltage	Control voltage	I <sup>2</sup> t	External power supply required ?
SG444020	40A	115-265VAC	0-10VDC	1500A <sup>2</sup> s	No
SG464020	40A	200-460VAC	0-10VDC	1500A <sup>2</sup> s	
SG468020	70A	200-460VAC	0-10VDC	5000A <sup>2</sup> s	
SG469020	110A	200-460VAC	0-10VDC	20000A <sup>2</sup> s	
SG444120	40A	115-265VAC	Potentiometer	1500A <sup>2</sup> s	
SG464120	40A	200-460VAC	Potentiometer	1500A <sup>2</sup> s	
SG469120	110A	200-460VAC	Potentiometer	20000A <sup>2</sup> s	
SG444420	40A	115-265VAC	4-20mA	1500A <sup>2</sup> s	
SG464420	40A	200-460VAC	4-20mA	1500A <sup>2</sup> s	
SG468420	70A	200-460VAC	4-20mA	5000A <sup>2</sup> s	
SG469420	110A	200-460VAC	4-20mA	20000A <sup>2</sup> s	



● Dim. 100 x 73.5 x 39.5 mm (3.94 x 2.87 x 1.54 in)

All these products must be mounted on heatsinks in order to reach nominal performances.

## S04

You can find more information on the standards applicable to our products by referring to our technical datasheets.



### Phase angle controllers

The S04 are our phase angle controllers in okpac® housing (to mount on heatsinks). The microcontroller controlling these controllers can adapt the function to your application. This range is primarily suited to resistive loads.

Product reference	Max. switching current	Switching voltage	Control voltage	External power supply required ?	Fig. n°
SO445020	50A	100-280VAC	0-10V	yes	1
SO465020	50A	200-480VAC	0-10V	yes	1
SO468020	95A	200-480VAC	0-10V	yes	1
SO469020	125A	200-480VAC	0-10V	yes	1
SO468120	95A	200-480VAC	0-5V	yes	1
SO467501	75A	160-450VAC	1-5V	no	3
SO445320	50A	100-280VAC	Potentiometer	yes	1
SO465320	50A	200-480VAC	Potentiometer	yes	1
SO445420	50A	100-280VAC	4-20mA	no	2
SO465420	50A	200-480VAC	4-20mA	no	2
SO467420	75A	200-480VAC	4-20mA	no	2
SO468420	95A	200-480VAC	4-20mA	no	2
SO469420	125A	200-480VAC	4-20mA	no	2
SO465620	50A	200-480VAC	PWM	yes	1

All these products must be mounted on heatsinks in order to reach nominal performance.

#### REMINDER

celduc® relais offers analog power controllers for resistive loads that use a PWM input to control the operation of the thyristor. As a result, the power applied to the load is directly proportional to the PWM signal on the input of the power controller. This control mode allows a PLC or other control system to perform proportional control of the load similar to a 0-10V or 4 - 20mA signal. The duty cycle is defined by  $\alpha = \frac{t_{on}}{t_{on} + t_{off}}$ .



1 ● Dim. 45 x 58.2 x 27 mm



2 ● Dim. 45 x 58.2 x 27 mm



3 ● Dim. 45 x 58.2 x 27 mm (1.77 x 2.28 x 1.06 in)

# Single phase analog controllers



## SIL4 / SIM4

### « Ready to use » Phase angle controllers

Our SIL4 range is housed in a celpac® unit (ready to use). The microcontroller managing these controllers can adapt the function to your application. This range is mainly designed for resistive loads.

Product reference	Max. switching current at 40°C	Switching voltage	Control voltage	External power supply required ?
SIL465000	28A	160-450VAC	0-10V	no
SIL465400	28A	160-450VAC	4-20mA	no
SIM465000	35A	160-450VAC	0-10V	no

You can find more information on the standards applicable to our products by referring to our technical datasheets.



● Dim. 22.5 x 80 x 116 mm  
(0.87 x 3.15 x 4.57 in)

● Dim. 45 x 80 x 116 mm  
(1.77 x 3.15 x 4.57 in)

## SO3

### Burst control mode (µP based unit)

This control mode is ideal for resistive loads that have a low thermal inertia, such as short wave infrared emitters (infrared heater bulbs). It also makes it possible for the power to be finely modulated in accordance with the analog control, while limiting disturbances.

This control mode consists of switching the streams of full sine waves equally distributed along a fixed modulation period (TM) in accordance with the analog input signal. The µP constantly computes the number of full sine waves to be switched along the TM period.

Product reference	Max. switching current at 40°C	Switching voltage	Control voltage	External power supply required ?
SO367001	75A	160-450VAC	0-10VDC	no

Other ratings and controls are available on request.

You can find more information on the standards applicable to our products by referring to our technical datasheets.

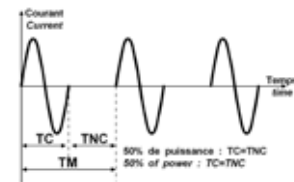

● Dim. 45 x 58.2 x 27 mm (1.77 x 2.28 x 1.06 in)

## Multizone power controller

celduc® relais has developed a multizone controller that can be used to monitor and control infrared heating lamps. Based on solid state relay technology, this system can control up to 12 lamps in a precise and efficient way. Software in the system allows the PLC to be notified of the operating state and possible faults of the components managed by the power controller application.

### Key features:

- ▶ Controls a maximum of 12 IR channels (4kW max. per channel and 36kW max. per box)
- ▶ U<sup>2</sup> type mains variations compensation (syncopated)
- ▶ Fault Detections:
  - broken lamp < 250 ms
  - over/undervoltage
  - overheating
  - fuse failure
  - thyristor short-circuit
  - fan issues
- ▶ Built-in Protections : short circuit, dv/dt transients and overvoltage
- ▶ Control and Diagnostics using Profibus DP



EIRC control unit



# Single phase and three-phase analog controllers

## SG5

### Full wave pulse controllers

This relay has an analog input isolated from the mains to proportionally vary the operating duty cycle of a load (t/T) in relation to the input voltage. This control mode consists of switching the streams of full sine waves equally distributed along a fixed modulation period (TM) in accordance with the analog input signal. Models equipped with an LED and protection via RC and VDR network. Application: temperature control.

You can find more information on the standards applicable to our products by referring to our technical datasheets.

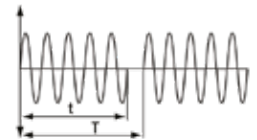

Product reference	Max. switching current	Switching voltage	Control voltage	I <sup>2</sup> t	External power supply required ?
SG541020	10A	115-253VAC	0-10VDC	72A <sup>2</sup> s	no
SG544020	40A	115-253VAC	0-10VDC	610A <sup>2</sup> s	
SG564020	40A	200-440VAC	0-10VDC	610A <sup>2</sup> s	
SG544120	40A	115-253VAC	Potentiometer	610A <sup>2</sup> s	
SG564120	40A	200-440VAC	Potentiometer	610A <sup>2</sup> s	
SG541420	10A	115-253VAC	4-20mA	72A <sup>2</sup> s	
SG564420	40A	200-440VAC	4-20mA	610A <sup>2</sup> s	



● Dim. 100 x 73.5 x 39.5 mm (3.94 x 2.87 x 1.54 in)

For higher power ratings and three-phase applications, please request a copy of our application notes. All these products must be mounted on heatsinks in order to reach nominal performance.

## SWG5

### Single phase power controllers

These controllers have an analog input isolated from the mains to proportionally vary the operating duty cycle of a heating element (heating element batteries). This control mode consists of switching the streams of full sine waves equally distributed along a fixed modulation period (TM) in accordance with the analog input signal. Application: Single phase battery.

You can find more information on the standards applicable to our products by referring to our technical datasheets.



1



● Dim. 100 x 74 x 56 mm (3.94 x 2.91 x 2.20 in)

2



● Dim. 100 x 110 x 96 mm (3.94 x 4.33 x 3.78 in)

Product reference	Max. switching power	Switching voltage	Control voltage	External power supply required ?	Fig. n°
SWG50210	2kW	115-253VAC	0-10VDC	no	1
SWG50810	8kW	115-253VAC	0-10VDC		2

0-5V control voltage or potentiometer available on request

## SWG8

### Three-phase power controllers

The SWG8 three-phase controllers consist of a 0-10VDC control module and a power module customized for the load to switch. The control module has an analog input isolated from the mains to proportionally vary the operating duty cycle of a heating element (heating element batteries) connected to the power module.

You can find more information on the standards applicable to our products by referring to our technical datasheets.



Product reference	Max. switching power	Switching voltage	Control voltage
SWG81510	20kW	24-520VAC	0-10VDC
SWG82710	27kW	24-520VAC	0-10VDC
SWG83610	36kW	24-520VAC	0-10VDC
SWG84210	42kW	24-520VAC	0-10VDC
SWG84810	48kW	24-520VAC	0-10VDC
SWG86010	60kW	24-520VAC	0-10VDC
SWG88010	80kW	24-520VAC	0-10VDC
SWG88020	80kW	24-520VAC	4-20mA

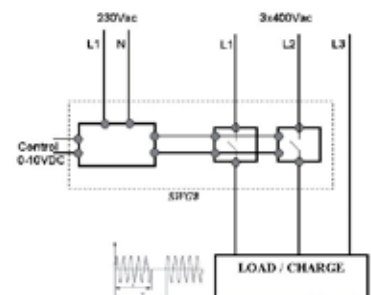

● For dimensions, please refer to the data sheet

# Three-phase proportional controllers



## SVTA

You can find more information on the standards applicable to our products by referring to our technical datasheets.



### Key features

- ▶ Three-phase phase angle controllers with six proportional control thyristors (balanced currents, less harmonics, etc.)
- ▶ Start and stop ramps (increases the unit's service life)
- ▶ Diagnostic functions
- ▶ Compact housing..

### Typical applications

- ▶ Controls any type of load (except capacitive loads), 3 or 4-wire (neutral), delta or star assembly:
- ▶ Resistive loads for temperature control (infrared lamps, furnaces, heating elements, etc.)
- ▶ Resistive loads for lighting control (filament and halogen lamps, UV, stage lighting, etc.)
- ▶ Loads including a transformer, an induction coil or a rectifier for voltage control (rectified power supplies, high voltage generators, etc.)
- ▶ Motor loads for speed control (depending on the type of motor and machine).



● Dim. 100 x 76 x 58.5 mm  
(3.94 x 2.99 x 2.28 in)

Product reference	Max. switching current AC-1 at 40°C	Max. switching current AC-3 at 40°C	Control	External power supply required ?
SVTA4650E	3 x 50A	3 x 12A	0-10V	no
SVTA4651E	3 x 50A	3 x 12A	Potentiometer	
SVTA4684E	3 x 95A (*)	3 x 22.5A	4-20mA	
SVTA4690E	3 x 125A (*)	3 x 30A	0-10V	
SVTA4691E	3 x 125A (*)	3 x 30A	Potentiometer	
SVTA4694E	3 x 125A (*)	3 x 30A	4-20mA	

\* Maximum current, max. cross sectional area = 10 mm<sup>2</sup>, use double wires or special adaptors for currents > 50A. Please refer to the heatsink installation instructions.

## SGTA

You can find more information on the standards applicable to our products by referring to our technical datasheets.



Our SGTA range is complementary to our SVTA three-phase proportional controllers.

### Key features

- ▶ Minimal dimensions
- ▶ Extensive network frequency (40-65Hz)
- ▶ Built-in overvoltage protection
- ▶ High I<sup>2</sup>t power elements
- ▶ Control of isolated thyristors using optical couplers during the entire cycle and the 3 phases (balanced currents, less harmonics, etc.)
- ▶ The minimum voltage applied on the load is the lowest in the market (3% RMS compared to 40% RMS offered by our competitors!)
- ▶ A wide range of options are available on request
- ▶ Manufactured in compliance with the major international standards: EMC, LVD, UL, VDE.

### Typical applications

- ▶ Resistive loads for temperature control (infrared lamps, furnaces, heating elements, etc.)
- ▶ Resistive loads for lighting control (filament and halogen lamps, stage lighting, etc.)



● Dim. 75.15 x 100 x 46 mm  
(2.95 x 3.94 x 1.81 in)

Product reference	Max. switching current AC-1 at 40°C	Switching voltage	Control	External power supply required ?
SGTA4650	3 x 50A	300-510VAC	0-10V	An 8-32V external power supply is required.
SGTA4651	3 x 50A	300-510VAC	0-5V	
SGTA4653	3 x 50A	300-510VAC	Potentiometer	
SGTA4654	3 x 50A	300-510VAC	4-20mA	

Other ratings are available on request.



# DC Solid State Relays

These relays are designed to switch DC loads, e.g solenoid valves, brakes, LEDs, motors (possibly on AC mains under specific conditions). The following technologies are available:

## Nominal current

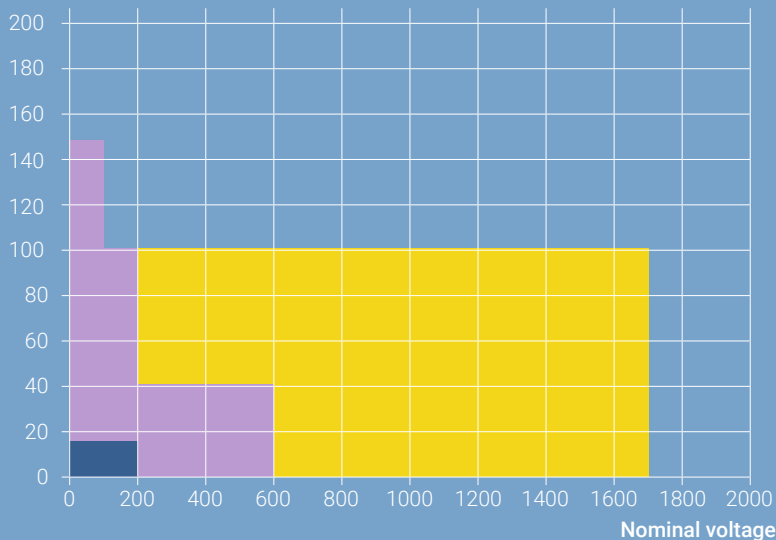

### BIPOLAR

For applications where a low control current is required.

### MOSFET

For applications requiring transient overcurrent withstand (motors).

### IGBT

For high voltage applications (> 600VDC)

A technology for every application! Currently up to 1700Vdc and 150A.

## MOSFET technology

You can find more information on the standards applicable to our products by referring to our technical datasheets.

Product reference	Switching current	Switching voltage	Peak voltage	Control voltage	Protection
SLD01205	4A	0-32VDC	60V	3-10VDC	TVS
SLD02205	4A	0-32VDC	60V	7-20VDC	TVS
SLD03205	4A	0-32VDC	60V	18-32VDC	TVS
SLD03210	2.5A	0-60VDC	60V	18-32VDC	TVS
STD03205	2.5A	0-30VDC	60V	10-30VDC	TVS
STD03505	5A	0-30VDC	60V	10-30VDC	TVS
STD03510	5A	0-68VDC	60V	10-30VDC	TVS
STD07205	2.5A	0-30VDC	60V	12-30VDC 15-30VAC	TVS
SPD03505	5A	0-30VDC	60V	10-30VDC	TVS
SPD07505	5A	0-30VDC	60V	12-30VDC 15-30VAC	TVS
SKLD11006	10A	7-36VDC	60V	3-10VDC	TVS
SKLD30520	8A	12-100VDC	200V	18-32VDC	TVS
SKLD31006	10A	7-36VDC	60V	7-30VDC	TVS
SCM0100200	100A	2-200VDC	200V	4.5-32VDC	Backward diode
SCM0150100	150A	2-100VDC	100V	4.5-32VDC	Backward diode
SCM030200	30A	2-200VDC	200V	4.5-32VDC	Backward diode
SCM040600	40A	2-600VDC	600V	4.5-32VDC	Backward diode
SOM020100	20A	5-60VDC	100V	3.5-32VDC	TVS
SOM020200	20A	5-110VDC	200V	3.5-32VDC	TVS
SOM02060	20A	5-40VDC	60V	3.5-32VDC	TVS
SOM040100	40A	5-60VDC	100V	3.5-32VDC	TVS
SOM040200	40A	5-110VDC	200V	3.5-32VDC	TVS
SOM04060	40A	5-40VDC	50V	3.5-32VDC	TVS
SOM06075	60A	5-40VDC	75V	3.5-32VDC	TVS
ESO01000	0-80A	0-130VDC	200V	Voltage protection option (C1, D2) for the SOM range	Diode + capacitor
XKLD0020	4A	10-100VDC	200V	18-32VDC	TVS + diode + fuse
XKLD31006	10A	10-40VDC	60V	10-30VDC	VDR



● SLD Dim. 28 x 5 x 15 mm (1.10 x 0.20 x 0.59 in)



● STD Dim. 29 x 12.7 x 15.7 mm (1.14 x 0.47 x 0.59 in)



● SPD Dim. 29 x 12.7 x 25.4 mm (1.14 x 0.47 x 0.98 in)



● SKLD Dim. 43.6 x 6.3 x 24.5 mm (1.69 x 0.24 x 0.94 in)



● SCM Dim. 44.5 x 58.2 x 27 mm (1.73 x 2.28 x 1.06 in)



● SOM/ESO Dim. 45 x 58.5 x 30 mm (1.77 x 2.28 x 1.18 in)



● XKLD0020 Dim. 36 x 78 x 61mm



● XKLD31006 Dim 12.2 x 76.4 x 53mm





## BIPOLAR Technology

You can find more information on the standards applicable to our products by referring to our technical datasheets.

Product reference	Switching current	Switching voltage	Peak voltage	Control voltage	Protection
SKD10306	3A	2-60VDC	60V	3-30VDC	Backward diode
XKD10120	1A	2-220VDC	220V	5-30VDC	Backward diode
XKD10306	3A	2-60VDC	60V	5-30VDC	Backward diode
XKD11306D	3A	2-60VDC	60V	3-30VDC	Backward diode
XKD70306	3A	2-60VDC	60V	10-30VAC/DC	Backward diode
XKD90306	3A	2-60VDC	60V	90-240VAC/DC	Backward diode
SCC10506	5A	2-60VDC	60V	3-16VDC	Backward diode
SCC20506	5A	2-60VDC	60V	10-32VDC	Backward diode
SCC21506	15A	2-60VDC	60V	10-32VDC	Backward diode



● SKD  
Dim. 28 x 5 x 15 mm  
(1.10 x 0.20 x 0.59 in)



● XKD  
Dim. 12.2 x 76.4 x 53 mm  
(0.47 x 2.99 x 2.09 in)



● SCC  
Dim. 44.5 x 58.2 x 27 mm  
(1.73 x 2.28 x 1.06 in)



## IGBT Technology

You can find more information on the standards applicable to our products by referring to our technical datasheets.



Product reference	Switching current	Switching voltage	Peak voltage	Control voltage	Protection
SCI0100600	100A	0-350VDC	600V	4.5-32VDC	Backward diode
SCI0251700	25A	0-820VDC	1700V	4.5-32VDC	Backward diode
SCI0501200	50A	0-750VDC	1200V	4.5-32VDC	Backward diode
SMI00201600	20A	500-940VDC	1600V	16.8-36VDC	<ul style="list-style-type: none"> <li>▶ Short-circuit protection with fault feedback</li> <li>▶ Undervoltage lock-out protection for primary side and secondary side (UVLO)</li> <li>▶ Overvoltage and rapid transient protection</li> </ul>
SDI0501700	✓ 50A	12-940VDC	1700V	24-48VDC	Depending on models :
SDI0501710	✓ 50A	12-940VDC	1700V	72-110VDC	<ul style="list-style-type: none"> <li>▶ Overvoltage and rapid transient protection</li> <li>▶ Load overvoltage and short circuit protection</li> <li>▶ Temperature protection</li> </ul>
SDI1001700	100A	12-940VDC	1700V	24-48VDC	



● SCI  
Dim. 44.5 x 58.2 x 27 mm  
(1.73 x 2.28 x 1.06 in)



● SDI  
Dim. 157 x 68 x 83 mm  
(6.18 x 2.68 x 3.27 in)



● SMI  
Dim. 45 x 100 x 30 mm  
(1.77 x 3.94 x 1.18 in)

With celduc® relais, your switches on continuous networks are under control!

### REMINDER

Products without protection (Transil or varistor (VDR)) or only protected by a diode must be equipped with an external overvoltage protection. The maximum operating voltage is usually equal to half the specified maximum switchable voltage.

**ON REQUEST:**  
"ready to use" products,  
current protected with  
built-in voltage protection,  
proportional control and  
DC motor inverters.  
**Please contact us!**





## Heatsinks

### REMINDERS

In order to get the optimal performance from our Solid State Relays (SSR) you need to follow our mounting instructions. Here are our top 6 tips for an optimal installation of SSRs.

- 1▶ Heatsink mounted in a way to allow heat dissipation
- 2▶ Use a thermal interface between the SSR baseplate and the mounting surface
- 3▶ Do not mount SSRs on a plastic or painted surface
- 4▶ Observe the screw terminal tightening torque of between 1.2 and 1.8Nm maximum
- 5▶ The heatsink should be positioned with the fins in a vertical position
- 6▶ Take thermal issues into consideration when mounting multiple SSRs in a confined area

Product reference	Fig n°	Thermal characteristics	Specifications				Dimensions (in) (l x d x h)"	SSRs range	Number and type of relays to be mounted		
			Ventilation	Thermo-contact	Rail DIN mounting	Screw mounting			22.5mm (0.89 in)	45mm (1.77 in)	73.5 / 76.5 / 100mm (2.89 / 3.01 / 3.94 in)
WF031100	1	0.3K/W	230Vac	Yes (NC type)	Yes	Yes	4.33 x 4.72 x 5.71	SA, SC, SG, SI, SM, SO, SU, SV	3 (SA, SI, SU)	2 (SO, SC, SM)	1 (SG, SV)
WF031200	1	0.3K/W	24Vdc	Yes (NC type)	Yes	Yes	4.33 x 4.72 x 5.71	SA, SC, SG, SI, SM, SO, SU, SV	3 (SA, SI, SU)	2 (SO, SC, SM)	1 (SG, SV)
WFF051210	2	0.5K/W	24Vdc	Yes (NC type)	Yes	No	45x116x135	SA, SC, SI, SM, SO, SU	1 (SA, SI, SU)	1 (SO, SC, SM)	-
WF050000	3	0.55K/W	No	No	As an option	Yes	4.33 x 3.94 x 7.87	SA, SC, SG, SI, SM, SO, SU, SV	1 (SA, SI, SU)	1 (SO, SC, SM)	1 (SG, SV)
WF070000	4	0.75K/W	No	No	As an option	Yes	4.33 x 3.50 x 4.72	SA, SC, SG, SI, SM, SO, SU, SV	1 (SA, SI, SU)	1 (SO, SC, SM)	1 (SG, SV)
WF115100	5	0.9K/W	No	No	Yes	Yes	4.33 x 3.94 x 3.54	SA, SC, SG, SI, SO, SU, SV	1 (SA, SI, SU)	1 (SO, SC)	1 (SG, SV)
WF112100	6	1K/W	No	No	Yes	Yes	1.93 x 4.61 x 4.72	SA, SI, SU	1 (SA, SI, SU)	-	-
WF108110	7	1.1K/W	No	No	Yes	Yes	3.50 x 3.19 x 3.86	SA, SC, SI, SO, SU	1 (SA, SI, SU)	1 (SO, SC)	-
WF121000	8	1.2K/W	No	No	Yes	Yes	3.94 x 1.57 x 3.94	SA, SC, SG, SI, SM, SO, SU, SV	3 (SA, SI, SU)	2 (SO, SC, SM)	1 (SG, SV)
WF114200	9	1.75K/W	No	No	Yes	No	1.77 x 2.87 x 3.94	SA, SC, SI, SM, SO, SU	1 (SA, SI, SU)	1 (SO, SC, SM)	-
WF210000	10	2.1K/W	No	No	As an option	Yes	3.78 x 1.61 x 2.17	SA, SC, SI, SO, SU	1 (SA, SI, SU)	1 (SO, SC)	-
WF151200	11	2.2K/W	No	No	Yes	Yes	1.77 x 2.87 x 3.15	SA, SC, SI, SO, SU	1 (SA, SI, SU)	1 (SO, SC)	-
WF311100	12	3K/W	No	No	Yes	Yes	0.87 x 2.87 x 3.15	SA, SI, SU	1 (SA, SI, SU)	-	-

The Rth values are provided for a temperature build-up of 50°C in still air. Other dimensions available on request.







## DIN-Rail adaptors

Product reference	Fig n°	Specifications	Width in mm	SSRs range	Number and type of relays to be mounted			Heatsinks models
					22.5mm (0.89 in)	45mm (1.77 in)	73.5 / 76.5 / 100mm (2.89 / 3.01 / 3.94 in)	
1L936100	1	Top hat section DIN rail Adaptor TH35-15 (35 mm x 15 mm) according to IEC 60715	105	SG, SV	-	-	1 (SG, SV)	WF05 / WF07
1LD00100	2	Top hat section DIN rail Adaptor TH35-15 (35 mm x 15 mm) & TH35-7.5 (35 mm x 7.5 mm) according to IEC 60715	25	SA, SC, SM, SO, SU	1 (SA, SU)	1 (SO, SC, SM)	-	-
1LD00400	3	Top hat section DIN rail Adaptor TH35-15 (35 mm x 15 mm) & TH35-7.5 (35 mm x 7.5 mm) according to IEC 60715	85	-	-	-	-	WF21 / WF07 / WF05
1LD12020	4	Top hat section DIN rail Adaptor TH35-15 (35 mm x 15 mm) & TH35-7.5 (35 mm x 7.5 mm) according to IEC 60715	45	SA, SC, SM, SO, SU	2 (SA, SU)	1 (SO, SC, SM)	-	-



## Other accessories

### PROTECTION COVERS / FLAPS

1K199000	Protective cover for SG9
1K522000	Protective cover for SA-SAL
1K523000	Removable protective flaps for SU-SUL



### MOUNTING KITS

1L382300	4.8mm angled Faston 45°
1L386100	6.3 mm angled Faston 45°
1LK00100	mounting SC-SO-SF-SM-SU on heatsink or SC-SO on 1LD12020
1LK00200	mounting SG-SVT-SV9 on heatsink
1LK00300	mounting heatsinks on 1LD00400 or SC-SO on 1LD00000
1LK00700	special kit for high current (okpac range)

### MARKING LABELS

1MZ09000	marking labels to be mounted on protective flaps or covers
----------	--

### MOUNTING+HEATSINK+DIN ADAPTOR OPTION

1LWD1202	SC/SO mounting on 1LD12020 + 1LD12020
----------	---------------------------------------

### MOUNTING OPTION ONLY AVAILABLE IF QUANTITY > 10 (MOUNTING KIT INCLUDED)

1LW00000	relay mounting on heatsink
1LWD00000	heatsink mounting on DIN rail adaptor

### THERMAL SEALS RELAY/HEATSINK

5TH15000	thermal paste for 30 SG/SVT relays or 60 SC/SO relays
5TH21000	precut thermal film for SC/SO
5TH23000	adhesive thermal seal for SC/SO
5TH24000	adhesive thermal seal for SA/SU
1LWP2300	5TH23000 factory installation on SC/SO + 5TH23000
1LWP2400	5TH24000 factory installation on SC/SO + 5TH24000



### INPUT CONNECTORS

		SSRs range
1Y020915	2 pole screw connector	SOB (1 ctrl), SU
1Y020001	2 pole push-in connector 180°	SOB (1 ctrl), SOBR, SU, SOR
1Y022715	2 pole screw connector 270°	SOB (1 ctrl), SU
1Y040005	4 pole push-in connector 180°	SOB (2 ctrls), SOBR, SGTR
1Y040915	4 pole screw connector 90°	SOB (2 ctrls)
1Y042217	4 pole screw connector 45°	SOB (2 ctrls)
1Y042715	4 pole screw connector 270°	SOB (2 ctrls)
1Y044604	4 pole spring connector 180°+ locking	SOB (2 ctrls)



# Reed magnetic sensors

## Magnetic proximity sensors

### We are the experts

If your application needs position, presence, level or speed detection, then take a look at the available solutions from our range of magnetic sensors.

If you cannot find the right product for your application, don't worry we can even design a specific product that meets your requirements: 70% of our magnetic proximity sensors are custom devices developed according to customer specifications. celduc® has over 60 years of experience in this product category and we look forward to working with you to optimize your application with the right sensor.

Tell us about your project  
and we'll provide the  
solutions.

### Contents

<b>APPLICATIONS</b> .....	49
<b>SOME TECHNICAL REMINDERS</b> .....	50
<b>CUSTOMER SPECIFIC PRODUCTS</b> .....	51
<b>REED MAGNETIC SENSORS</b>	
• Screw position sensors .....	52-53
• Tubular position sensors .....	54-56
• Sensors for lifts .....	56
• Sensors for printed circuits .....	56
• Sensors for window frames .....	57
• Level sensors .....	58-59
• Safety sensors .....	60
• ATEX sensors .....	61
<b>CONTROL MAGNETS</b> .....	62



## Applications

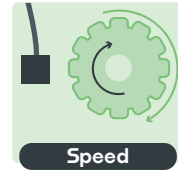
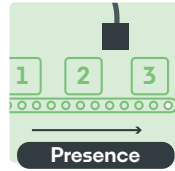
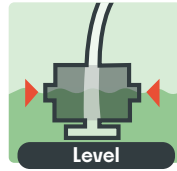
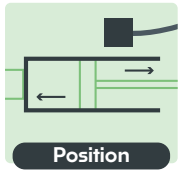

### ► Industrial:

- Counting
- Cylinder position
- Machine safety
- Advertising panel
- Actuator position
- Liquid level
- Speed control

### ► Home:

- Burglar alarm
- Window position
- Lifts / elevators
- Window blind / Shutter control
- Household appliances
- Inputs for centralized control panels
- Swimming pools

### ► Aircraft, space and military :

- Fuel level
- Oil and water level
- Camera shutter control
- Sensors and actuators for aircraft



## Sensors and connected objects

You can connect our sensors using our energy efficient mobile communication solutions!

Using networks specific to the Internet of things, our energy efficient wireless link modules can connect all types of detection equipment. Thanks to our professional expertise in the magnetic detection sector and the combination of reed technology and LPWAN networks (low-power wide-area networks), our sensors are:

- **autonomous:** up to 10 years of uninterrupted use without changing or recharging the batteries,
- **interconnected:** from your mobile phone or computer, you can directly access the status of your position and level sensors and receive alerts of any changes,
- **simple to use:** with no SIM card and no complex configurations, you can manage your sensors directly via our web platform and you can connect anywhere in the world with the same model,
- **cost-effective:** much more affordable than traditional mobile networks, LPWAN solutions are ideal for connected sensors and today have a global coverage of more than 90%.

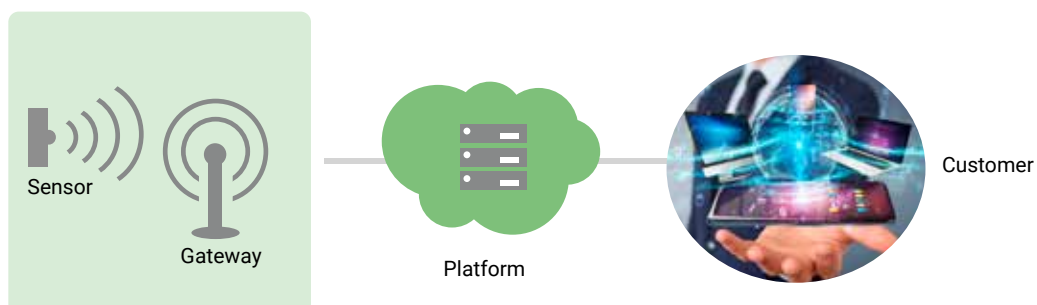



# Reed magnetic sensors

## What is a magnetic proximity sensor?

The sensing element of a magnetic sensor is a Reed switch which detects the presence of a magnetic field, in general this is a permanent magnet. It detects the position of a magnet without contact and transmits an electrical go-no-go or analog signal, depending on the specific part used.

## Reed switch sensors

A Reed switch consists of a pair of ferromagnetic flexible metal contacts in a hermetically sealed glass envelope, filled with an inert gas. The contacts are usually normally open, closing when a magnetic field is present, or they may be normally closed and open when a magnetic field is applied.

### There are different contact types

- ▶ NO / Form A > Normaly Open
- ▶ NC / Form B > Normaly Closed
- ▶ BISTABLE NO / Form I
- ▶ CHANGE-OVER / Form C

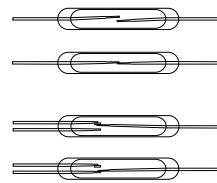

## The main advantages are :

- AC and DC switching
- No power supply required,
- Can operate in harsh environments,
- Extensive sensing range (depending on the magnetic sensitivity of the switch, the power of the magnet as well as the magnetic environment),
- Cost-effective solution.
- Long service life

### REMINDER

Reed switches and detectors using reed switches can switch both AC and DC currents.

The values provided in our data sheets for current and voltage are maximum values. It means that in DC applications it represents the maximum switching current and voltage. In AC applications these values are peak values. To calculate the nominal value you should divide this by 1.414.

## Control magnets

To control Reed switch, a magnet must be used. Please go to page 62 to review our complete range of coated and uncoated magnets.

### The sensor/magnet combination must be selected in accordance with how the parts will be used

- ▶ Required activation distance (action and release),
- ▶ Operating temperature,
- ▶ Operating mode (perpendicular or parallel movement? Face-to-face activation?),
- ▶ Geometry,
- ▶ Required corrosion resistance, etc.

### REMINDER

The guaranteed activation distance depends on the sensor's sensitivity and the magnet's power. In this selection guide, we provide an example of a guaranteed activation distance for a given magnet. However, celduc® is always here to help you choose the best magnet/sensor combination for your needs.



## Customer specific products

More than 70% of our sensors are manufactured in accordance with customer specifications. Here are a few examples:

### ► Aircraft

Supplying this industry is proof of our reliability. celduc® relais has developed special sensors to detect the opening/closing of doors, for example, push-buttons used to detect open/closed doors in the Airbus A380; sensors to detect tank refueling in the Dassault Rafale and Saab JAS 39 Gripen fighters; level sensors for AIRBUS humidifiers, etc.



### ► Nuclear

celduc® relais has designed and manufactured sensors for controlling nuclear reactors. These sensors are used in a system with extremely high safety levels. Our sensors have therefore undergone rigorous performance testing in very difficult conditions.

Developing sensors for nuclear reactors once again demonstrates the ability of celduc® relais to create customized solutions in industries where reliability is critical.



### ► Agriculture

In agriculture, there are many ways in which our magnetic sensors can be applied. celduc® has developed a magnetic proximity sensor for metal detection. No more magnets needed!



### ► Industrial Level sensors

**Our Salespeople will work with our R&D team to develop an optimal solution that meets your specifications.**

We will consider the type of material to use, wire, cable, connector, specific accessory, etc. so as to provide the right product for your application. We developed this 2-position Reed level sensor using stainless steel to take into account its use with special fluids that can react chemically with polypropylene.



### ► Industrial sensor

Initially developed for use on industrial chain hoists, our PTB10030 can be used in various applications as a limit switch. Equipped with a normally closed contact with a power of 60W/230VAC/DC/1A, its housing allows simple screw mounting and wire connections are made via a 2-point Mini-Fit type removable connector.



**A TEAM OF EXPERTS  
AT YOUR SERVICE**



# Reed magnetic sensors

## Screw-mounted position sensors

General purpose sensors (screw-mounted), for industrial and domestic uses:

- ▶ Window sensors
- ▶ Door opening
- ▶ Presence of protective covers
- ▶ White goods.

### IoT solutions

Connect our Reed sensors to a communication system so that they are autonomous and networked (see page 49).



Product reference	PAA10060	PAA11202	PAA11210	PAA20011	PAB10020	PLA10100	PLA10160	PLA11208	PLA12430
Contact status	NO	NO	NO	NO	NC	NO	NO	NO	NO
Connection type	2-wire / FASTON	2-wire	2-wire	2-wire + connector MOLEX	2-wire + connector HE14	Cable	2-wire	Cable	Cable
Cable length	2.28ft	0.90ft	3.28ft	0.04in	0.52ft	32.81ft	1.18ft	2.62ft	9.84ft
Max. switching power	10VA	12VA	12VA	10VA	3VA	10VA	12VA	12VA	10VA
Max. switching voltage	48VAC 100VDC	48VAC 100VDC	48VAC 100VDC	48VAC 100VDC	48VAC 100VDC	150VAC 250VDC	48VAC 100VDC	110VAC 250VDC	150VAC 250VDC
Max. switching current	0.5A	0.5A	0.5A	1A	0.25A	0.5A	0.5A	0.4A	0.5A
Activation distance	0.59in with P6250000	0.59in with P6250000	0.59in with P6250000	0.79in with P6250000	0.71in with P6250000	0.39in with P6250000	0.59in with P6250000	0.63in with P6250000	0.47in with P6250000
Working temperature	-40 to +85°C	-40 to +100°C	-40 to +100°C	-40 to +100°C	-40 to +100°C	-40 to +85°C	-40 to +85°C	-40 to +100°C	-40 to +100°C
Dimensions (in inches)	0.91x0.55 x0.24	0.91x0.55 x0.24	0.91x0.55 x0.24	0.91x0.55 x0.24	0.91x0.55 x0.24	1.26x0.59 x0.24	1.26x0.59 x0.24	1.26x0.59 x0.24	1.26x0.59 x0.24
Fixing screws distance	0.55in	0.55in	0.55in	0.55in	0.55in	0.67in	0.67in	0.67in	0.67in



Product reference	PLA13701	PLA13730	PLA13750	PLA42302	PLA43403	PLB10060	PLB16701	PLC10040	PLC13701
Contact status	NO	NO	NO	NO	NO	NC	NC	Change-over	Change-over
Connection type	Cable	Cable	Cable	Cable	Cable	Cable	Cable	Cable	3 wires
Cable length	0.33ft	9.84ft	16.40ft	0.98ft	0.98ft	9.84ft	0.33ft	4.92ft	0.33ft
Max. switching power	12VA	12VA	12VA	50VA	100VA	12VA	12VA	NC : 3VA NO : 8VA	NC : 3VA NO : 8VA
Max. switching voltage	150VAC 250VDC	150VAC 250VDC	150VAC 250VDC	230VAC 350VDC	230VAC 350VDC	150VAC 250VDC	150VAC 250VDC	48VAC 100VDC	48VAC 100VDC
Max. switching current	0.4A	0.4A	0.4A	0.5A	1A	0.4A	0.4A	0.25A	0.25A
Activation distance	0.39in with P6250000	0.39in with P6250000	0.39in with P6250000	0.47in with P6250000	0.47in with P6250000	0.16<d <0.47in (magnet provided)	0.16in (supplied with magnet)	0.55in with P6250000	0.39in with P6250000
Working temperature	-40 to +85°C	-40 to +85°C	-40 to +85°C	-40 to +85°C	-40 to +100°C	-40 to +100°C	-40 to +100°C	-40 to +100°C	-40 to +100°C
Dimensions (in inches)	1.26x0.59 x0.57	1.26x0.59 x0.57	1.26x0.59 x0.57	1.26x0.59 x0.57	1.26x0.59 x0.57	1.26x0.59 x0.57	1.26x0.59 x0.57	1.26x0.59 x0.57	1.26x0.59 x0.57
Fixing screws distance	0.67in	0.67in	0.67in	0.67in	0.67in	0.67in	0.67in	0.67in	0.67in

# Reed magnetic sensors

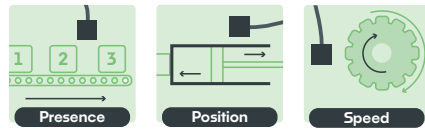

## IoT solutions

Connect our Reed sensors to a communication system so that they are autonomous and networked (see page 49).



Product reference	PB195T00	PB367G00	PB390G00	PBA13725	PBA13780	PSL40010	PS2A0020	PSC41000	PSC42000
Contact status	NO	NC	NO	NO	NO	NO	2NO	Change-over	Change-over
Connection type	2-wire	2-wire	2-wire	Cable	Cable	2-wire	Cable	Cable	Cable
Cable length	0.26ft	0.26ft	7.09ft	8.20ft	26.25ft	1.80ft	6.56ft	1.31ft	16.40ft
Max. switching power	50VA	16VA	16VA	12VA	12VA	10VA	10VA	100VA	100VA
Max. switching voltage	250VAC	150VAC 250VDC	150VAC 250VDC	150VAC 250VDC	150VAC 250VDC	230VAC 350VDC	48VAC 100VDC	300VAC	300VAC
Max. switching current	1A	0.5A	0.5A	0.4A	0.4A	0.5A	1A	3A	3A
Activation distance	0.28in with P4160000	0.16in with P4159000	0.51in with P4160000	0.51in with P4160000	0.51in with P4160000	0.47in with P6250000	0.59in with P6250000	0.28in with P0540000	0.28in with P0540000
Working temperature	-40 to +100°C	-40 to +85°C	-40 to +85°C	-40 to +100°C	-40 to +100°C	-40 to +85°C	-40 to +85°C	-25 to +85°C	-25 to +85°C
Dimensions (in inches)	3.39x0.31 x0.47	2x0.31 x0.43	2x0.31 x0.43	2x0.31 x0.43	2x0.31 x0.43	2x0.63 x0.28	2x0.63 x0.28	2x0.63 x0.28	2x0.63 x0.28
Fixing screws distance	2.95in	1.57in	1.57in	1.57in	1.57in	0.63in	0.63in	0.63in	0.63in

## Sensors with metal housing



Product reference	PLMA0100
Contact status	NO
Connection type	1 shielded cable
Cable length	2.92ft
Max. switching power	10VA
Max. switching voltage	110VAC 200VDC
Max. switching current	0.5A
Activation distance	1.18in (magnet provided)
Working temperature	-40 to +85°C
Dimensions (in inches)	3.46x1.50x0.47
Fixing screws distance	2.72in

## Screw sensors with safety loop (Alarms)



Product reference	PBA10010
Contact status	NO
Connection type	cable + safety loop
Cable length	26.25ft
Max. switching power	12VA
Max. switching voltage	110VAC 250VDC
Max. switching current	0.4A
Activation distance	0.63in with P4160000
Working temperature	-40 to +100°C
Dimensions (in inches)	2x0.31x0.43
Fixing screws distance	1.57in

## UL approved sensors



Product reference	PLA10101U	PLA12435U	PLA12432U-A
Contact status	NO	NO	NO
Connection type	2-wire UL1061 + connector Micro-Fit 6 points	Cable	Cable
Cable length	1.31ft	1.15ft	1.05ft
Max. switching power	10VA	10VA	10VA
Max. switching voltage	48VAC 100VDC	48VAC 100VDC	48VAC 100VDC
Max. switching current	0.5A	0.4A	0.5A
Activation distance	0.39in with P6250000	0.47in with P6250000	0.39in with P6250000
Working temperature	-40 to +85°C	-40 to +100°C	-10 to +80°C
Dimensions (in inches)	1.26x0.59x0.24		
Fixing screws distance	0.67in		

Double-sided adhesive for quick fixing



# Reed magnetic sensors

## Tubular position sensors

General purpose tubular sensors for industrial and commercial use:

- ▶ Window sensors
- ▶ Door opening
- ▶ Presence of protective covers
- ▶ White goods.

### IoT solutions

Connect our Reed sensors to a communication system so that they are autonomous and networked (see page 49).

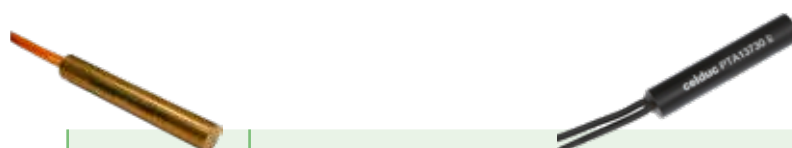
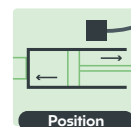
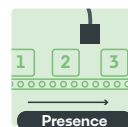

Product reference	PTA10490	PTA10440	PTA11235	PTA12401	PTA13730	PTA50010	PTB13702	PTC13730
Contact status	NO	NO	NO	NO	NO	NO	NC	Change-over
Max. switching power	10VA	12VA	12VA	12VA	12VA	12VA	3VA	NC : 3VA NO : 8VA
Max. switching voltage	48VAC 100VDC	48VAC 100VDC	48VAC 100VDC	48VAC 100VDC	48VAC 100VDC	48VAC 100VDC	48VAC 100VDC	48VAC 100VDC
Max. switching current	0.4A	0.4A	0.4A	0.4A	0.4A	0.4A	0.25A	0.25A
Connection type	2-wire 2.62ft	2-wire 1.64ft	Cable 8.20ft	2-wire 0.33ft	2-wire 9.84ft	2-wire 0.33ft	2-wire 0.66ft	Cable 9.84ft
Activation distance	0.63in with P6250000	0.28in with P6250000	0.59in with P6250000	0.55in with P6250000	0.39in with P6250000	0.71in with P6250000	0.55in with P6250000	0.28in with P6250000
Working temperature	-40 to +120°C	-40 to +85°C	-40 to +85°C	-40 to +85°C	-40 to +85°C	-40 to +85°C	-40 to +85°C	-40 to +85°C
Dimensions (in inches)	Ø0.24x1.61	Ø0.24x1.18	Ø0.24x1.18	Ø0.24x1.18	Ø0.24x1.18	Ø0.24x0.99	Ø0.24x1.18	Ø0.24x1.18
Material	Brass	Plastic	Plastic	Plastic	Plastic	Plastic	Plastic	Plastic



Product reference	PTPA0030	PTPA0100	PTPA0110	PTPA0230	PTPB0011	PTPA0330
Contact status	1NO	1NO	1NO	1NO	1NC	1NO
Max. switching power	12VA	12VA	12VA	12VA	12VA	12VA
Max. switching voltage	48VAC 100VDC	48VAC 100VDC	48VAC 100VDC	48VAC 100VDC	48VAC 100VDC	48VAC 100VDC
Max. switching current	0.5A	0.5A	0.5A	0.5A	0.5A	0.5A
Connection type	2-wire 9.84ft	Connectors	Connectors	2-wire 9.84ft	2-wire 0.26ft + FASTON	2-wire 9.84ft
Activation distance	0.47in (magnet provided)	0.47in (magnet provided)	consult us	0.79in (magnet provided)	0.39in (magnet provided)	consult us
Working temperature	-40 to +85°C	-40 to +85°C	-40 to +85°C	-40 to +85°C	-40 to +85°C	-40 to +85°C
Dimensions (in inches)	Ø0.43x1.10	Ø0.43x1.10	Ø0.43x1.10	Ø0.91x1.06	Ø0.91x1.10	Ø0.91x1.10
Material	Plastic	Plastic	Plastic	Plastic	Plastic	Plastic



# Reed magnetic sensors



Typical applications:

- ▶ Speed sensors,
- ▶ Presence/position/ motion sensors.

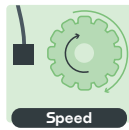
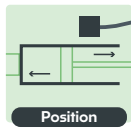
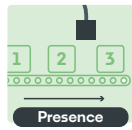

## IoT solutions

Connect our Reed sensors to a communication system so that they are autonomous and networked (see page 49).

## PTI M8 housing



Product reference	PTI40003	PTI40020	PTI40030	PTI50020	PTIC0030	PTI10122	PTI60020	PTI60022	PTI62310	PTI70020
Contact status	1NO	1NO	1NO	1NC	Change-over	1NO	1NO	1NO	1NO	1NC
Max. switching power	12VA	12VA	12VA	5VA	5VA	10VA	12VA	12VA	100VA	5VA
Max. switching voltage	110VAC 200VDC	110VAC 200VDC	110VAC 200VDC	110VAC 175VDC	110VAC 175VDC	48VAC 100VDC	110VAC 200VDC	110VAC 200VDC	300VAC 350VDC	110VAC 175VDC
Max. switching current	0.5A	0.5A	0.5A	0.25A	0.25A	0.10A	0.5A	1A	1A	0.25A
Connection type	Cable 0.98ft	Cable 6.56ft	Cable 9.84ft	Cable 6.56ft	Cable 9.84ft	Cable 72.18ft	Cable 6.56ft	Cable 7.55ft + connector MOLEX	2 wires 3.28ft	Cable 6.56ft
Activation distance	0.20in with PT505000	0.20in with PT505000	0.20in with PT505000	2.28in with PT505000	0.59in with UR801000	0.47in with PT505000	0.47in with UR801000	0.59in with UR801000	0.51in with UR801000	0.28in with UR801000
Working temperature	-40 to +85°C	-40 to +85°C	-40 to +85°C	-40 to +85°C	-40 to +85°C	-40 to +85°C	-40 to +85°C	-40 to +85°C	-40 to +200°C	-40 to +85°C
Dimensions (in inches)	M8 - Lg 1.22	M8 - Lg 1.22	M8 - Lg 1.22	M8 - Lg 1.22	M8 - Lg 1.22	M8 - Lg 1.57	M8 - Lg 1.73	M8 - Lg 1.73	M8 - Lg 1.57	M8 - Lg 1.73
Material	Plastic	Plastic	Plastic	Plastic	Plastic	Stainless steel	Stainless steel	Stainless steel + Support	Stainless steel	Stainless steel

## PDC / PDLA / PTA / PTC / PTI M10 housing



Product reference	PDC20030	PDLA2030	PTA80020	PTA90160	PTC10091	PTI92304
Contact status	Change-over Form C	Bistable Form L	1NO Form A	1NO	Change-over	1NO
Max. switching power	60VA	100VA	12VA	12VA	NC : 3W NO : 8W	50VA
Max. switching voltage	250VAC	250VAC	110VAC 200VDC	48VAC 100VDC	48VAC 100VDC	300VDC
Max. switching current	1A	1A	0.5A	0.4A	0.25A	0.5A
Connection type	Cable 9.84ft	Cable 9.84ft	Cable 26.56ft	Cable 4.92ft	Cable 0.33ft	Cable 1.31ft with connector
Activation distance	0.79in with UP102008	consult us	0.59in with UR144360	0.47in with P6250000	0.79in with UR124540	0.87in with UF261204
Working temperature	-40 to +75°C	-40 to +75°C	-40 to +85°C	-40 to +125°C	-25 to +85°C	-40 to +80°C
Dimensions (in inches)	M10x0.04 - Lg 3.35	M10x0.04 - Lg 3.35	M10x0.04 - Lg 1.73	M10 - Lg 1.57	M8x0.04 - Lg 1.61	M12x1 - Lg 1.85
Material	Plastic	Plastic	Stainless steel	Brass	Brass	Brass

▶ Sensors with M12 housing page 56



# Reed magnetic sensors

## IoT solutions

Connect our Reed sensors to a communication system so that they are autonomous and networked (see page 49).

### PC M12 housing

Typical applications: ▶ Lifts: sensors with 2 or 3 normally open contacts are used to detect the position of the cabin and are also used as an automatic level reset according to the weight in use.  
▶ Position/motion sensors.



Product reference	PCA22330	PCA36720	PCC12320	PCC26720	PCLA3030	PC2A2330	PC3A2330
Contact status	1xNO	1xNO	Change-over	Change-over	Bistable	2xNO	3xNO
Max. switching power	70VA	120VA	3VA	60VA	120VA	70VA	70VA
Max. switching voltage	300VAC	250VAC	100VAC/DC	250VAC	250VAC	300VAC	300VAC
Max. switching current	0.5A	3A	0.25A	1A	3A	0.5A	0.5A
Connection type	Cable 9.84ft	Cable 6.56ft	Cable 6.56ft	Cable 6.56ft	Cable 9.84ft	Cable 9.84ft	Cable 9.84ft
Activation distance	0.79in with UR144361	0.59in with UR144361	0.98in with UR144361	0.71in with UR144360	1.18in with UP081508	0.79in with UR144361	0.79in with UR144361
Working temperature	-40 to +75°C	-25 to +75°C	-25 to +75°C	-40 to +75°C	-40 to +75°C	-40 to +75°C	-40 to +75°C
Dimensions (in inches)	M12 L 3.15	M12 L 3.16	M12 L 3.17	M12 L 3.18	M12 L 3.19	M12 L 3.20	M12 L 3.21
Material	Plastic	Plastic	Plastic	Plastic	Plastic	Plastic	Plastic

Sensors with M12x1 L50 housing on request

### PMG Sensors for lifts (and other industrial applications)

Sensors for: ▶ Lift position detection  
▶ Door opening control



Product reference	PMG12921	PMG12924	PMG12930S	PMG13051
Contact status	NO	NO	NO bistable	NC
Max. switching power	100VA	120VA	60VA	30VA
Max. switching voltage	230VDC	250VAC	110VAC 230VDC	110VAC 230VDC
Max. switching current	3A	3A	1A	0.5A
Cable length	Cable 22.97ft	Cable 22.97ft	Cable 23.95ft	Cable 21.33ft
Activation distance	consult us	consult us	consult us	consult us
Working temperature	-25 to +85°C	-25 to +85°C	-25 to +85°C	-25 to +85°C
Dimensions (in inches)	M14 x 2.95 - Lg 2.95	M14 x 2.95 - Lg 2.95	3.15x1.18x1.18	M14 x 2.95 - Lg 2.95

### PHA / PHC To install on PCB

Overmolded reed switch sensors for mounting on PCBs in complete safety (no switch embrittlement).



Product reference	PHA01200	PHA11200	PHC13700
Contact status	NO	NO	Change-over
Max. switching power	12VA	12VA	NC : 3VA / NO : 8VA
Max. switching voltage	48VAC 100VDC	48VAC 100VDC	48VAC 100VDC
Max. switching current	0.4A	0.4A	0.25A
Working temperature	-40 to +100°C	-40 to +100°C	-40 to +100°C
Dimensions (in inches)	0.91x0.16x0.12	0.91x0.16x0.12	0.91x0.16x0.12

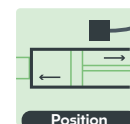
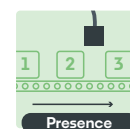

# Reed magnetic sensors



## IoT solutions

Connect our Reed sensors to a communication system so that they are autonomous and networked (see page 49).

## PWA / PWB / PWC

### Sensors for window frames

This new range has been developed to detect the position of a window: open or closed (monitoring opening). Typical applications are centralized building management systems, air conditioning and heating.

Main advantages are:

- Installation and connection time reduced by half: locking pluggable connectors, clip-mounted (no mounting screws)
- Open, closed contact, inverter, safety loop
- Dust and weather proof contact.

### Quick and easy to install!

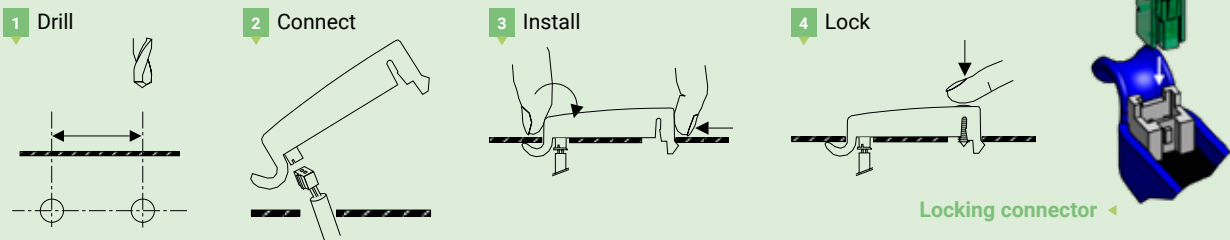

Product reference	PWA21501	PWB01501	PWA11500	PWB11500	PWC01500
Contact(s) status	NO	NC	NO + safety loop	NC + safety loop	Change-over
Contact status	Window open				
	Window closed				
Connection type	8cm harness with integrated locking connector. Cable + PAP-025V-S connector (not included)	Cable + PAP-025V-S connector (not included)	Cable + PHR4 4 poles connector (not included)		
Cable length (to be ordered separately)	Ref. 2YB20031 : 9.84ft Ref. 2YB20051 : 16.40ft Ref. 2YB20111 : 32.80ft Ref. 2YB20131 : 42.65ft Ref. 2YB20151 : 49.21ft Ref. 2YB20251 : 82.02ft		Ref. 2YB40080 : 8m		
Max. switching power	10VA	3VA	10VA	3VA	3VA
Max. switching voltage	48VAC 100VDC	48VAC 100VDC	48VAC 100VDC	48VAC 100VDC	48VAC 100VDC
Max. switching current	0,4A	0,4A	0,4A	0,4A	0,4A
Activation distance	Depend on magnet - see technical data-sheet				
Working temperature	-40 to +70°C	-40 to +70°C	-40 to +70°C	-40 to +70°C	-40 to +70°C
Dimensions (in inches)	1.85 x 0.35 x 0.37	1.85 x 0.35 x 0.37	1.85 x 0.35 x 0.38	1.85 x 0.35 x 0.39	1.85 x 0.35 x 0.40



► Clip-on **PW520000** magnet



► Screw-mounted **UR102540, UR124540 and UR144360** magnets



► **UZ189538** magnet attached with glue



# Level magnetic sensors

## PTF / PTFA

celduc relais® has a wide range of standard or custom level and flow sensors with Reed switches.

Since our sensors are available in various plastic and stainless steel housings, we can accommodate a wide range of applications, depending on the chemicals and operating temperatures used.

For specific applications, (e.g.: potentiometric scale, special level sensors) please contact us: we can develop products to meet your needs.

### IoT solutions

Connect our Reed sensors to a communication system so that they are autonomous and networked (see page 49).

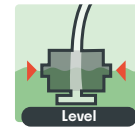

Product reference		PTF01070	PTFA1015	PTFA1103 <sup>(1)</sup>	PTFA5001 <sup>(1)</sup>	PTFA1210	PTFA2115 <sup>(1)(2)</sup> PTFA2115R	
Vertical level sensors	Type of mounting	Vertical	Vertical	Vertical	Vertical	Vertical High and low level	Vertical	
	Contact status (float down)		1NO	1NO	1NC	1NC	1NO+NC	1NO (PTFA2115) 1NC (PTFA2115R)
	Connection type		2-wire 2.76in	2-wire 4.92ft	2-wire 0.98ft	Cable 6.56ft	Cable (3-wire) 0.98ft	2-wire 4.92ft
	Materials	Housing	Polyamide 6/6 resin with glass fiber content	Polyamide 6/6 resin with glass fiber content	Polypropylene	Polypropylene	Polyamide	Stainless steel
		Float	Polypropylene	Polypropylene	Polypropylene	Polypropylene	Polyurethane	Stainless steel
	Liquid compatibility		Water	Water	1	1	2	3
	Float travel		10mm	17mm	9mm	10mm	48,5mm	8mm
	Max. switching power		10VA	10VA	50VA	50VA	Top : 10VA Bottom : 3VA	50VA
	Max. switching voltage		48VAC 100VDC	48VAC 100VDC	300VAC/DC	300VAC/DC	Top : 200VDC Bottom : 100VDC	300VAC/DC
	Max. switching current		0.5A	0.5A	0.5A	0.5A	Top : 0.5A Bottom : 0.25A	0.5A
	Minimum density		0.8	0,75	0.7	0.9	0.6	0.75
	Working temperature		0 to +70°C	0 to +70°C	-10 to +80°C	-40 to +80°C	-10 to +85°C	0 to +100°C
	Thread		M8 x 0.04in	3/8" threading UNC 16 per inch - Lg 2.81in"	1/8" GAS 28 per inch - Lg 2.32in"	M8 x 0.04in	3/8" threading UNC 16 per inch - Lg 4.49in"	M10 x 1

(1) The function can be reversed by inverting the float

(2) Available in an approved version for ATEX areas (see page 61)

## Compatibility with fluids

1

- ▶ Compatible with the following acids: acetic, citric, formic, lactic, dilute nitric, phosphoric, dilute sulphuric; soda; alcohol: ethanol, methanol, propanol; glycol; mineral oil; water.
- ▶ Not compatible with the following solvents: chloroform, methylene chloride, trichlorethylene, toluene; strong acids.

2

- ▶ Compatible with gas oil, petrol, kerosene, lubricating oil, mineral, vegetable and animal oils
- ▶ Not compatible with almost all acids; alkalis; methylene chloride
- ▶ Acceptable resistance to water

3

- ▶ Compatible with almost all liquids except for some specific strong acids.



## Operation

Thanks to its magnetic field, a float fitted with one or more magnets moves with the fluid and activates a hermetically sealed Reed contact.

## IoT solutions

Connect our Reed sensors to a communication system so that they are autonomous and networked (see page 49).

## Advantages

The following advantages ensure user safety, repeatability, accuracy and operational reliability combined with low maintenance.

- ▶ A single moving part: the float.
- ▶ Since Reed switches are only activated by a magnetic field, there is no wear and tear.
- ▶ Because Reed switches are hermetically sealed, there are no ingress protection issues.



					
Product reference	PTFA0100	PTFA3115	PTFA3002	PTFA3315 <sup>(1)</sup>	PTFA3415
Type of mounting	Horizontal External mounting	Horizontal	Horizontal	Horizontal	Horizontal External mounting
Contact status (float down)	1NO	1NO	1NO	1NO	1NO
Internal resistance	No	No	Yes	No	No
Connection type	2-wire 6.89in + Molex connector	2-wire 4.92ft	Cable 65.62ft	2-wire 4.92ft	2-wire 4.92ft
Materials	Polyamide 30% glass fiber	Polyamide 30% glass fiber	Polypropylene	Polypropylene	Polypropylene
Liquid compatibility					
Float travel	45°	45°	45°	45°	45°
Max. switching power	10VA	50VA	50VA	50VA	50VA
Max. switching voltage	110VAC / 200VDC	300VAC/DC	300VAC/DC	300VAC/DC	300VAC/DC
Max. switching current	0.5A	0.5A	0.1A	0.5A	0.5A
Minimum density	0.6	0.6	0.6	0.6	0.6
Working temperature	0 to +85°C	0 to +85°C	-10 to +100°C (wires/85°C)	-10 to +100°C (wires/85°C)	-10 to +100°C (wires/85°C)
Thread	Specific	Specific	M16 x 2	M16 x 2	M16 x 2

(2) Available in an approved version for ATEX areas (see page 61)

## Applications

**Heating** (air conditioning, heaters, humidifiers)

- ▶ To detect the tank's water level.

**Domestic equipment** (electronic toilet flush system, solar energy)

- ▶ To detect the water level.

**Food industry** (coffee machines, drink vending machines)

- ▶ The sensor provides information which activates a pump to maintain the water level.

**Medical equipment** (sterilizers)

- ▶ Water level.

**Water treatment** (water purifiers, water makers)

- ▶ The sensor is used to detect the required supply level.

**Swimming pools** (water treatment, water heating)

- ▶ Water level and flow.

**Automotive** (to check water levels, ABS brake fluid, presence of water in fuel, washer fluid)

- ▶ To detect the various liquid levels.

**Various industries** (self-service photo booths, electric car wash, etc.)





# Safety magnetic sensors



By preventing any dangerous equipment activity, they protect operators when opening protective guards, doors or covers.

2 safety levels compliant with standards EN ISO 13849-1 and EN ISO 62061:

The latest safety standards are based on concepts such as the security level (SIL) or the performance level (PL).

**SIL 1 / 2 / 3**  
**PL = c / d / e**  
 (our safety sensors should be used with an adapted safety module)

## PSS / PXS

PXS or PSS products are designed to detect the opening of protective devices, machine housings and access doors of equipment considered to be dangerous.



Coded magnet P3000100 to be ordered separately

Product reference	PXS10350	PXS59010	PXS59150	PXS70150	PXS79010	PXS79020	PXS79050	PXS79150
Contact status	2NO + 1NC	1NO + 1NC	1NO + 1NC	2NO + 1NC	2NO	2NO	2NO	2NO
Current limiting resistor	-	10Ω	10Ω	10Ω	-	-	-	10Ω
Max. switching power	3VA	3VA	3VA	3VA	3VA	3VA	3VA	3VA
Max. switching voltage	48VAC 100VDC	48VAC 100VDC	48VAC 100VDC	48VAC 100VDC	48VAC 100VDC	48VAC 100VDC	48VAC 100VDC	48VAC 100VDC
Max. switching current	400mA	100mA	100mA	100mA	400mA	400mA	400mA	100mA
Cable length	Cable 16.40ft	Cable 32.80ft	Cable 16.40ft	Cable 16.40ft	Cable 32.80ft	Cable 6.56ft	Cable 16.40ft	Cable 16.40ft
Activation distance	0.31in	0.31in	0.31in	0.31in	0.31in	0.31in	0.31in	0.31in
Associated magnet	P2000100	P2000100	P2000100	P2000100	P2000100	P2000100	P2000100	P2000100
LED option	no	no	yes	yes	no	no	no	yes
Working temperature	-25 to +85°C	-25 to +85°C	-25 to +85°C	-25 to +85°C	-25 to +85°C	-25 to +85°C	-25 to +85°C	-25 to +85°C



Coded magnet P3000100 to be ordered separately



Product reference	PSS59050	PSS59150	PSS79050	PSS79150	PSA60010	PSA60015	PSA60020
Contact status	1NO + 1NC	1NO + 1NC	2NO	2NO	1NO solid state	1NO solid state	1NO solid state
Current limiting resistor	10Ω	10Ω	-	10Ω	-	-	-
Max. switching power	3VA	3VA	3VA	3VA	12VA	500VA	12VA
Max. switching voltage	48VAC 100VDC	48VAC 100VDC	48VAC 100VDC	48VAC 100VDC	24-440VAC	24-440VAC	8-440VAC
Max. switching current	100mA	100mA	400mA	100mA	3A	3A	3A
Cable length	Cable 16.40ft	Cable 16.40ft	Cable 16.40ft	Cable 16.40ft	2-wire 4.92ft	Cable 4.92ft	2-wire 9.84ft
Activation distance	0.20in	0.20in	0.20in	0.20in	0.47in	0.47in	0.47in
Associated magnet	P3000100	P3000100	P3000100	P3000100	P6250000	P6250000	P6250000
LED option	no	yes	no	yes	no	no	no
Working temperature	-25 to +85°C	-25 to +85°C	-25 to +85°C	-25 to +85°C	-25 to +85°C	-25 to +85°C	-25 to +85°C

Cable termination is either M8 or M12 depending on the part. See datasheets for additional details.



# ATEX magnetic sensors



celduc® relais is a certified ATEX product manufacturer under number INERIS 04ATEXQ406.celduc®  
relais also has an EC type examination certificate, number INERIS 04ATEX0105.  
Group II for surface industries.



Marking example : for part number PL.1...Ex (for other part numbers, please refer to the respective technical data-sheet)

**CE0080**  **II 2 GD** **Ex mb IIC T6 Gb**  
**Ex tb IIIC IP67 T85°C Db**  
**II 1 GD** **Ex ia IIB T6 Ga**  
**Ex ia IIIB T85°C Da**

Type of devices: 1 for zone 0 (continuous risk)  
2 for zone 1 (intermittent risk)

Gas : G or Dust : D  
Protection "m" for zone 1 and "i" for zone 0  
Temperature class : T6 (85°C) T4 (135°C) or T3 (200°C)  
Cables length 5m or 10m.



Product reference	PLA1125Ex	PLB1179Ex	PLC1125Ex	PTA1125Ex
Contact status	1NO	1NC	Change-over	1NO
Temperature classification	T6	T6	T6	T6
Max. switching power	12VA	12VA	NC : 3VA NO : 8VA	12VA
Max. switching voltage	60VDC	60VDC	60VDC	60VDC
Max. switching current	0.4A	0.4A	0.25A	0.4A
Cable length	Cable 16.40ft	Cable 32.80ft	Cable 16.40ft	Cable 16.40ft
Working temperature	-40 to +80°C	-40 to +80°C	-40 to +80°C	-40 to +80°C
Type of housing	Plastic	Plastic	Plastic	Plastic
Dimensions in inches	1.26x0.59x0.24	1.26x0.59x0.24	1.26x0.59x0.24	Ø0.24x1.18



Product reference	PFA2125Ex	PFA3125Ex	PSS1905Ex	PSS5905Ex	PSS7905Ex	PTA6125Ex	PTA9125Ex
Contact status	1NO	1NO	1NO	1NO + 1NC	2NO	1NO	1NO
Temperature classification	T6	T6	T4	T4	T4	T4/T6 or T3/T6*	T4/T6 or T3/T6*
Max. switching power	12VA	12VA	12VA	3VA	3VA	12VA	12VA
Max. switching voltage	60VDC	60VDC	60VDC	60VDC	60VDC	60VDC	60VDC
Max. switching current	0.4A	0.4A	0.1A	0.1A	0.1A	0.4A	0.4A
Cable length	Cable 16.40ft	Cable 16.40ft	Cable 16.40ft	Cable 16.40ft	Cable 16.40ft	Cable 16.40ft	Cable 16.40ft
Working temperature	-40 to +80°C	-40 to +80°C	-25 to +85°C	-25 to +85°C	-25 to +85°C	-40 to +200°C	-40 to +200°C
Type of housing	Stainless steel	Polypropylene	Polyamide	Polyamide	Polyamide	Brass	Brass
Dimensions in inches	Ø1.10x2.36	Ø1.10x3.54	2x0.63	2x0.63	2x0.63	Ø0.24x1.61	M10

\*Refer to the data-sheets



## We offer a wide range of permanent magnets to activate our sensors.

To control Reed switch magnetic sensors, a magnet must be used. Choose from one of celduc® relais' three different ranges of magnets, which are differentiated as follows: operating temperature, geometry and corrosion resistance.

Magnet material		Max. operating temperature	Temperature drift coefficient (reversible)	Corrosion resistance	
Alnico		500°C	very low (-0,025% par °C)	Good resistance	generally supplied in bars whose length must be at least 4 times the diameter
Ferrite		250°C	high (-0,20% par °C)	Very good resistance	generally supplied as block rectangular types, discs or rings
Rare earth	Samarium-Cobalt (SmCo)	250°C	low (-0,04% par °C)	Very good resistance	generally supplied in blocks or pieces
	Neodymium Iron Boron (NdFeBo)	160°C	average (-0.10% par °C)	Poor resistance (must have tin or nickel coating)	generally supplied in blocks or pieces

Contact us if you need help in selecting the right sensor/magnet combination.

### Coated magnets

Product reference	For sensors	Uncoated magnets dimensions (in inches)	Dimensions (in inches)	Fig n°
P0540000	PSC	Ø 0.20 x 0.79	2 x 0.63 x 0.28	1
PA320000	PA	Ø 0.12 x 0.79	0.91 x 0.59 x 0.24	2
P2000100	PXS	Ø 0.39 x 0.39	2 x 0.63 x 0.28	3
P3000100	PSS	Ø 0.12 x 0.16	2 x 0.63 x 0.28	1
P3150000	PA, PH, PL, PT	Ø 0.12 x 0.59	1.26 x 0.59 x 0.24	4
P4200000	PA, PH, PL, PT	Ø 0.16 x 0.79	1.26 x 0.59 x 0.24	4
P6250000	PA, PH, PL, PT	Ø 0.24 x 0.98	1.26 x 0.59 x 0.24	4
P6250000-A	PA, PH, PL, PT	Ø 0.24 x 0.98	1.26 x 0.59 x 0.24	4
P4160000	PB or PLA	Ø 0.20 x 0.98	2 x 0.31 x 0.43	5
PT505000	PTI5 plastic	Ø 0.20 x 0.20	M8x1 Lg 1.22	6
PT810000	PTE	Ø 0.31 x 0.39	M12x1 Lg 1.22	7
PW520000	PWA, PWB, PWC	Ø 0.20 x 0.79	1.85 x 0.35 x 0.35	8



### Uncoated magnets

Product reference	Material		Fig n°
U315P003S	Alnico5	Ø 0.12 x 0.59	1
U4200000	Alnico5	Ø 0.16 x 0.79	1
U6250000	Alnico5	Ø 0.24 x 0.98	1
U8300000	Alnico5	Ø 0.31 x 1.18	1
UB105000	Alnico5	Ø 0.39 x 1.97	1
UF207760	Ferrite	0.79 x 0.28 x 0.24	2
UF221105	Ferrite	Ø 0.87 x 0.43 x 0.20	3
UF341605	Ferrite	Ø 1.34 x 0.63 x 0.20	3
UZ189538	Ferrite	0.71 x 0.35 x 0.12	2
UP051508	Plastoferrite	1.97 x 0.59 x 0.32	4
UP102008	Plastoferrite	3.94 x 0.79 x 0.32	4
UP301508	Plastoferrite	11.81 x 0.59 x 0.32	4
UP302008	Plastoferrite	11.81 x 0.79 x 0.32	4
UP302503	Plastoferrite	11.81 x 0.98 x 0.12	4
UR101000	NdFeBo	Ø 0.39x0.39	6
UR102540	NdFeBo	Ø 0.39x0.16x0.08	5
UR120500	NdFeBo	Ø 0.47x0.20	6
UR122000	NdFeBo	Ø 0.47x0.79	6
UR124540	NdFeBo	0.47x0.16x0.08	5
UR144360	NdFeBo	Ø 0.55x0.24x0.16	5
UR144361	NdFeBo	Ø 0.55x0.24x0.16	5
UR304000	NdFeBo	Ø 0.12x0.16	6
UR315000	NdFeBo	Ø 0.12x0.59	6
UR503000	NdFeBo	Ø 0.20x0.12	6
UR604010	NdFeBo	Ø 0.24x0.12	6
UR801000	NdFeBo	Ø 0.31x0.39	6





# Reed relays & switches



Detection : Clearance, position, level, presence  
Switching : Telecom, tester, measurement

## Reed switches

Detecting motion, positions and levels in harsh environments without any mechanical links between the moving parts, maintenance-free and subject to a magnetic field. This is the Reed contact's daily challenge. These contacts are used in a wide range of sectors, such as electronic banking, aerospace, automation, telecommunications, etc.

Product reference	Contact status	Max. switching voltage	Max. switching current	Max. switching power	Standard sensitivity range	Glass length
AC03	1NO	100VDC	0.5A	12VA	10-35ATf	0.39in
AC05		100VDC	0.5A	12VA	10-35ATf	0.55in
AD22		250VAC	1.3A	80VA	40-105ATf	2.05in
AD28		250VAC	3A	120VA	75-130ATf	2.05in
AI44		200VDC	0.75A	30VA	15-35ATf	0.81in
AJ21		100VDC	0.4A	10VA	10-35ATf	0.55in
AV10		7500VDC	0.3A	50VA	80-130ATf	2in
AX21		100VDC	0.5A	10VA	15-35ATf	0,56in
AX41		300VDC	1.5A	70VA	15-35ATf	0.80in
CD30		Change-over switch	500VAC/DC	3A	100VA	60-100ATf
CS26	400VAC/DC		1A	60VA	55-100ATf	1.42in

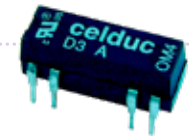

## Reed relays in DIP packages

We offer a large selection of contact options to support a wide range of industrial applications. These products are designed to switch PLC inputs, signals from sensors or safety devices.

Internal diagram (top view)	Product reference	Contact status	Characteristics of the switch			Characteristics of the coil		Specifications	Dimensions in inches
			Max. switching voltage	Max. switching current	Max. switching power	Nominal voltage	R. coil at 20°C		
	D31A3100	1NO	100VDC	0.5A	10VA	5VDC	500 Ω	—	0.75x0.26 x0.25
	D31A3110		100VDC	0.5A	10VA	5VDC	500 Ω	diode	
	D31A5100		100VDC	0.5A	10VA	12VDC	1 kΩ	—	
	D31A7100		100VDC	0.5A	10VA	24VDC	2150 Ω	—	
	D31A7110		100VDC	0.5A	10VA	24VDC	2150 Ω	diode	
	D31B3100	1NC	100VDC	0.5A	10VA	5VDC	500 Ω	—	0.75x0.26 x0.25
	D31B5100		100VDC	0.5A	10VA	12VDC	1 kΩ	—	
	D31C2100	Change-over	100VDC	0.25A	3VA	5VDC	200 Ω	—	0.75x0.26 x0.25
	D31C2110		100VDC	0.25A	3VA	5VDC	200 Ω	diode	
	D31C5100		100VDC	0.25A	3VA	12VDC	500 Ω	—	
	D31C5110		100VDC	0.25A	3VA	12VDC	500 Ω	diode	
	D31C7100		100VDC	0.25A	3VA	24VDC	2150 Ω	—	
	D31C7110		100VDC	0.25A	3VA	24VDC	2150 Ω	diode	
	D32A3100	2NO	100VDC	0.5A	10VA	5VDC	200 Ω	—	0.75x0.26 x0.25
	D32A3110		100VDC	0.5A	10VA	5VDC	200 Ω	diode	
	D32A5100		100VDC	0.5A	10VA	12VDC	500 Ω	—	
	D32A7100A		100VDC	0.5A	10VA	24VDC	2150 Ω	—	
	D71A2100	1NO	100VDC	0.5A	10VA	5VDC	380 Ω	—	0.75x0.26 x0.25
	D71A2110		100VDC	0.5A	10VA	5VDC	380 Ω	diode	
	D71A5100		100VDC	0.5A	10VA	12VDC	530 Ω	—	

## Reed relays in SIP packages

Relays for circuits with multiple components: alarms, testers, industrial controls, etc.

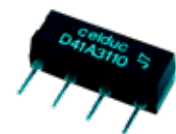

Internal diagram (top view)	Product reference	Contact status	Characteristics of the switch			Characteristics of the coil		Specifications	Dimensions in inches
			Max. switching voltage	Max. switching current	Max. switching power	Nominal voltage	R. coil at 20°C		
	D41A5100L	1NO	100VDC	0.5A	10VA	12VDC	1 kΩ	diode	0.75x(0.20 or 0.24)x0.30

# Reed relays & switches

The products on this page represent a small selection of our offering. If you cannot find a product that meets your needs, please contact us.

## High voltage relays

The withstand voltage between the contacts is greater than 10KVDC. The withstand voltage between the coil and the contacts is greater than 14VDC.



Product reference	Contact status	Max. switching voltage	Max. switching current	Max. switching power	Nominal voltage	R. coil at 20°C	Specifications	Dimensions in inches
R1329L00	1NO	7500VDC	0.2A	50VA	12VDC	300 Ω	without mounting screws	2.56 x 0.60 x 0.67
R1329L87		7500VDC	0.2A	50VA	12VDC	300 Ω		
R1343L00		7500VDC	0.2A	50VA	24VDC	1200 Ω		
R1343L13		5000VDC	0.2A	50VA	24VDC	1200 Ω		

## F and R Reed relays

Relays with very reliable ferromagnetic shielding, used in telecom applications, testers, measuring equipment, etc.



Internal diagram (top view)	Product reference	Contact status	Characteristics of the switch			Characteristics of the coil		Specifications	Dimensions in inches
			Max. switching voltage	Max. switching current	Max. switching power	Nominal voltage	R. coil at 20°C		
	F51A5100	1NO	250VDC	0.4A	14VA	12VDC	2145 Ω	comes in coated version ref. F81Ax100	1.18 x 0.37 x 0.39
	F81A5500 F81A7500	1NO Mercury	500VDC 500VDC	1A 1A	50VA 50VA	12VDC 24VDC	1000 kΩ 2300 Ω	Position vertically	1.18 x 0.37 x 0.39
	F61A2100 F61A7100	1NO	250VDC 250VDC	0.4A 0.4A	14VA 14VA	5VDC 24VDC	345 Ω 7845 Ω	Coil/contact insulation 4KV	1.18 x 0.37 x 0.43
	F72C2500 F72C5500 F72C7500	2 mercury wetted change-over switch	500VDC 500VDC 500VDC	1A 1A 1A	50VA 50VA 50VA	5VDC 12VDC 24VDC	75 Ω 350 Ω 1350 Ω	Position vertically	1.18 x 0.63 x 0.43



Internal scheme top view	Product reference	Contact status	Characteristics of the switch			Characteristics of the coil		Specifications	Dimensions in mm
			Max. switching voltage	Max. switching current	Max. switching power	Nominal voltage	R. coil at 20°C		
	R0292B00 R0293B08 R0294B08	1NO	100VDC 100VDC 100VDC	0.4A 0.4A 0.4A	12VA 12VA 12VA	4VDC 5VDC 12VDC	250 Ω 450 Ω 1600 Ω	—	0.91 x 0.30 x 0.26
	R0550B08	1NO	100VDC	0.4A	12VA	4VDC	500 Ω	DIL layout	0.80 x 0.39 x 0.28
	R0251W00 R0252W00 R0253W00	change-over	100VDC 100VDC 100VDC	0.25A 0.25A 0.25A	3VA 3VA 3VA	6VDC 12VDC 24VDC	150 Ω 500 Ω 1800 Ω	—	0.91 x 0.30 x 0.26
	R0115S06 R0116S06 R0117S06	1NO	250Veff 250Veff 250Veff	3A 3A 3A	100VA 100VA 100VA	6VDC 12VDC 24VDC	250 Ω 1000 kΩ 4 kΩ	step 5.08	2.56 x 0.61 x 0.63
	R0542B08 R0543B08	1NC	100VDC 100VDC	0.4A 0.4A	12VA 12VA	4VDC 5VDC	200 Ω 200 Ω	DIL layout	0.80 x 0.39 x 0.28
	R0861P12 R0761P00	mercury, wetted change-over switch	500VDC 500VDC	2A 2A	100VA 100VA	5VDC 24VDC	335 Ω 2650 Ω	position vertically	1.61 x 0.56 x 0.41
	R0866P00	2 mercury wetted change-over switch	500VDC	2A	100VA	5VDC	125 Ω	position vertically possible C.O.T.	1.61 x 0.56 x 0.41

# Catalogs and brochures available on request

Would you like to know more?

All our technical datasheets are available on our website.

## celduc® presentation

Who are we ?



[www.e-catalogue.celduc-relais.com](http://www.e-catalogue.celduc-relais.com)



## Catalogs and general information brochures



Product guide



The celpac® range: single phase solid state relays & contactors



The cel3pac® & sightpac® ranges: three-phase solid state relays & contactors



Solid state relays with push-in spring terminals



## Applications brochures

Railway • Plastic processing • Packaging • Food • Medical

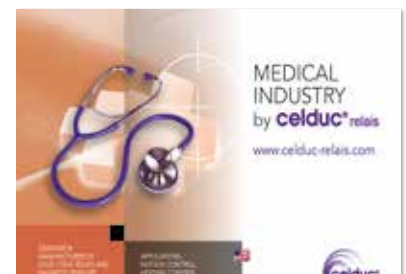

# celduc® relais

## is represented in more than 60 countries ...



Algeria  
Argentina  
Australia  
Austria  
Belgium  
Brazil  
Bulgaria  
Canada  
Chili  
China

Colombia  
Czech Republic  
Denmark  
Egypt  
Estonia  
Finland  
France  
Germany  
Greece  
Hong Kong

Hungary  
India  
Indonesia  
Irelande  
Israël  
Italy  
Japan  
Latvia  
Lithuania  
Malaysia

Mexico  
Morocco  
New Zealand  
Norway  
Paraguay  
Philippines  
Poland  
Portugal  
Romania

Russia  
Singapore  
Slovakia  
Slovenia  
South Africa  
South Korea  
Spain  
Sweden  
Switzerland

Taiwan  
Thailand  
The Netherlands  
Turkey  
Ukraine  
United Kingdom  
United States  
Venezuela  
Vietnam

## ...to listen to and better support our customers around the world.

celduc inc.  
434 E Main Street, #429, Centerport, NY 11721 USA  
Phone : (312) 420-0519

celduc's Headquarters  
5 rue Ampère - BP 30004 - 42290 Sorbiers - France  
Phone : +33 (0) 4 77 53 90 19

Your celduc® distributor/Your celduc® agent

[www.celduc-relais.com](http://www.celduc-relais.com)